

User Manual

www.accunIQ.com



ACCUNIQ

Adding accuracy to healthcare

User Manual
BC300



selvas 
Healthcare



The device bears the CE label in accordance with the provisions of Medical Device Directive 93/42/EEC.

THE PERSONS RESPONSIBLE FOR PLACING DEVICES ON THE EC MARKET UNDER MDD 93/42/EEC



SELVAS Healthcare, Inc.

155, Shinseong-ro, Yuseong-gu, Daejeon, 34109 Republic of Korea

TEL: 82-42-879-3000, FAX: 82-42-864-4462



VITAKO Sp. z o.o.

ul. Stanisława Żaryna 7c 02-593 Warszawa, POLAND

TEL: +48 505 522 888

CONTENTS

INTRODUCTION	5
1. INTENDED USE.....	5
2. WORD DEFINITIONS.....	5
3. CLASSIFICATION AND COMPLIANCE.....	6
4. SAFETY PRECAUTIONS.....	6
5. SAFETY SYMBOLS AND INFORMATION.....	9
6. Guidance for Electromagnetic compatibility(EMC)	11
ABOUT BODY COMPOSITION	17
TERM AND FUNCTION OF EACH PART	19
1. Main Body	19
2. Basic Package	24
3. Options	25
INSTALLATION	27
1. Installation of product	27
2. Power Supply	29
3. Peripheral Device Installation	30
1) Connecting Computer	30
2) Connecting Printer	31
3) Connecting Blood Pressure Monitor	32
4) Replacing Thermal Paper (Option)	33
SYSTEM SETUP	34
1. Entering SYSTEM SETUP	34
2. Menu in SYSTEM SETUP	34
3. Selecting a Menu in SYSTEM SETUP	34
4. Exiting SYSTEM SETUP	35
5. Moving to SYSTEM SETUP	35
6. Setup	36

MEASUREMENT AND ANALYSIS	44
1. Precautions for Measurement	44
2. Correct Posture	46
1) How to Touch Plate Electrodes	46
2) How to Touch Handle Electrodes	46
3) Measuring Posture	47
3. Measuring Procedure	48
1) Basic Analysis	48
2) Analysis Using Blood Pressure Monitor/Software Program	54
STORAGE OF DATA USING USB MEMORY	55
RESULT INTERPRETATION	57
STORAGE & MAINTENANCE	61
ERROR & REPAIR	62
1. Kinds of Error & Repair	62
2. Error & Repair	63
AFTER SERVICE	64
1. AFTTER SERVICE	64
2. PACKING AND TRANSPORT	64
SPECIFICATION	65
WARRANTY	67

INTRODUCTION

We highly appreciate that you chose our company's product.

You are kindly requested to be familiar with these directions before using this product and always keep it together with the product. In case you are not sure about any directions or problems arising while using the product, please contact our service center.

We will provide you with detailed instructions.

1. INTENDED USE

This device measures impedance by bioelectrical impedance analysis method and provides lots of information using measured impedance and inputted personal data (height, age, gender, weight).

It shows body composition of MBF, LBM, SLM, TBW, protein mass, mineral mass, etc. and information to BMI, PBF, BMR, abdominal analysis, AMB, segmental analysis, control guide, etc.

2. WORD DEFINITIONS

To ensure safe operation and long term performance stability, it is essential that you fully understand the functions, operating and maintenance instructions by reading this manual before operating your unit.

Particular attention must be paid to all warnings, cautions and notes incorporated herein.

The following conventions are used throughout the manual to denote information of special emphasis.

Warning



"Warning" indicates important information to the presence of a hazard which may cause severe personal injury, death or substantial property damage if the warning is ignored.

Caution



"Caution" indicates important information to the presence of a hazard which may cause minor personal injury or property damage if the caution is ignored.

Note



"Notice" indicates important information to notify installation, operation or maintenance of this device. "Notice" is important but not hazard-related. Hazard warnings are not included here.

3. CLASSIFICATION AND COMPLIANCE

- 1) This device is classified as;
 - Class 1 type-BF against electric shock
 - Ordinary equipment without protection against ingress of water
 - Equipment not suitable for use in presence of a flammable anesthetic mixture by standard of EN 60601-1: 2006(Basic safety and essential performance of Medical Electrical Equipment)
- 2) This device is complied with Class A for Noise-Emission, Level B for Noise-immunity, by standard of IEC 60601-1-2:2007(Electromagnetic Compatibility Requirements).

4. SAFETY PRECAUTIONS

This device is designed and manufactured with consideration of safety of the operator and subject and also to the reliability of the unit.

The following precautions must be observed for additional safety;

- ⚠ 1) The unit must be operated only by, or under supervision of a qualified person with our company or our distributors.
- ⚠ 2) This device is specified as Class 1 type BF unit under the standard of EN 60601-1: 2006(Basic safety and essential performance of Medical Electrical Equipment).
- ⚠ Therefore, patients must not touch or handle inner side of the system at any time.
- ⊘ 3) Do not modify the unit. If any modification is needed, ask our company or its authorized dealer for service.

- ⊘ 4) The unit has previously been adjusted in the factory for optimum performance.

Do not attempt to adjust switches or any other things except those specified in this manual for operation.

- ⚠ 5) If you have experienced any trouble with the unit, switch it off immediately, and contact our company or its authorized dealer for assistance.
- ⚠ 6) If you plan to connect any device of other manufacturers electrically or mechanically to the unit, contact our company or its authorized dealer for instructions before doing so.

When you connect computer or other system to the unit (RS-232C), the attached systems should be those certified by IEC 950 or equivalent standards for data processing equipment.

Configurations shall comply with the system standard EN 60601-1:2006.

Everybody who connects additional equipment to the signal input part or signal output part configures a medical system standard EN 60601-1:2006.

If in doubt, consult the A/S department of local distributor.

- ⚠ 7) Avoid the following environments for storage;
 - Where the ambient temperature falls -25°C or exceeds 70°C .
 - Where the atmospheric pressure falls below 70kPa (700mbar) or exceeds 106kPa (1060mbar).
 - Where the humidity is over 93% non-condensing.

- Where the unit is exposed to spray or splashing water.
- Where the unit is exposed to dust.
- Where the unit is exposed to water vapor.
- Where the unit is exposed to salty atmosphere.
- Where the unit is exposed to explosive gas.
- Where the unit is exposed to excessive shocks or vibrations.
- Where the angle of inclination of mounting surface exceeds 10 degrees.
- Where the unit is exposed to direct sunlight.

⚠ 8) This equipment has been tested and found to comply with the limits for medical devices to the IEC 60601-1-2:2007. These limits are designed to provide reasonable protection against harmful interference in a typical medical installation. This equipment generates uses and can radiate radio frequency energy and, if not installed and used in accordance with the instructions, may cause harmful interference to other devices in the vicinity. However, there is no guarantee that interference will not occur in a particular installation. If this equipment does cause harmful interference to other devices, which can be determined by turning the equipment off and on, the user is encouraged to try to correct the interference by one or more of the following measures:

- Reorient or relocate the receiving device.
- Increase the separation between the equipment.
- Connect the equipment into an outlet on a circuit different from that to which the other device(s) are connected.
- Consult the manufacturer or field service technician for help.

⊘ 9) Do not to touch signal input, signal output or other connectors, and the patient simultaneously.

⚠ 10) a statement that MEDICAL ELECTRICAL EQUIPMENT needs special precautions regarding EMC and needs to be installed and put into service according to the EMC information provided in the ACCOMPANYING DOCUMENTS;

⚠ 11) a statement that portable and mobile RF communications equipment can affect MEDICAL ELECTRICAL EQUIPMENT.

⚠ 12) Please consult a physician or a trained health professional for interpretation of measurement results.

Caution



Measurements may be impaired if this device is used near televisions, microwave ovens, X-ray equipment or other devices with strong electrical fields. To prevent such interference, use the meter at a sufficient distance from such devices or turn them off.

Note

Incorrect operation or failure of user to maintain the unit spares the manufacturer or his agent of the responsibility for system's non-compliance with specifications or responsibility for any damage or injury.

This manual is made for informational purpose and this manual and product are not meant to be a substitute for the advice provided by your own physician or other medical problem. You should not use the information contained in the product for diagnosis or treatment of health problem or prescription of medication by yourself.

If you have or suspect that you have a medical problem, consult with your physician promptly.

Defective unit or accessories must be packed in the replacement cartons to be shipped off from you to our company.

Shipping and insurance costs for return of defective unit must be prepaid by the users.









Note









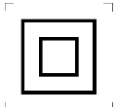

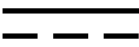

The equipment shall be connected to a center tapped single phase supply circuit when users in the United States connect the equipment to a 240 V supply system.

5. SAFETY SYMBOLS AND INFORMATION

The International Electrotechnical Commission (IEC) has established a set of symbols for medical electrical equipment which classifies a connection or warning of any potential hazard.

The classifications and symbols are shown below. Save these instructions for your safety.

	<p>Degree of protection against electric shock: TYPE BF</p>
	<p>Please observe operating instructions</p>
	<p>General warning sign</p>
	<p>General prohibition sign</p>
	<p>General mandatory action sign</p>
	<p>Caution</p>
	<p>Waste Electrical and Electronic Equipment (WEEE) The device could be sent back to the manufacturer for recycling or proper disposal after their useful lives. Alternatively the device shall be disposed in accordance with national laws after their useful lives.</p>
	<p>"ON / OFF" key : Turn the power ON / OFF</p>
	<p>Class II equipment</p>

	<p>This symbol is used inside system.</p> <p>Identifies the point where the safety ground of the system is fastened to the chassis.</p>
	<p>Do not open. This is for factory only.</p>
	<p>Alternating current</p>
	<p>Direct current</p>
	<p>Date of manufacture</p>
	<p>Manufacturer</p>
	<p>Non-ionizing radiation</p>
	<p>CE mark</p>
	<p>Serial No.</p>
	<p>Authorized representative in the European community.</p>
	<p>Keep dry</p>
	<p>For indoor use only</p>
	<p>RoHS2</p>

6. Guidance for Electromagnetic compatibility (EMC)

Details about the electromagnetic compatibility (EMC) of the ACCUNIQ BC300 are given below. Before using the ACCUNIQ BC300, be sure to read and understand the following information.

1) Guidance and manufacturer’s declaration – electromagnetic emissions

The ACCUNIQ BC300 is intended for use in the electromagnetic environment specified below. The customer or the user of the ACCUNIQ BC300 should assure that it is used in such an environment.

Emissions test	Compliance	Electromagnetic environment – guidance
RF emissions CISPR 11	Group 1	The ACCUNIQ BC300 uses RF energy only for its internal function. Therefore, its RF emissions are very low and are not likely to cause any interference in nearby electronic equipment.
RF emissions CISPR 11	Class B	The ACCUNIQ BC300 is suitable for use in all establishments, including domestic establishments and those directly connected to the public low-voltage power supply network that supplies buildings used for domestic purposes.
Harmonic emissions IEC 61000-3-2	Class A	
Voltage fluctuations/ flicker emissions IEC 61000-3-3	Compliance	

2) Guidance and manufacturer's declaration – electromagnetic immunity

The ACCUNIQ BC300 is intended for use in the electromagnetic environment specified below. The customer or the user of the ACCUNIQ BC300 should assure that it is used in such an environment.

Immunity test	IEC 60601 test level	Compliance level	Electromagnetic environment-guidance
Electrostatic discharge(ESD) IEC 61000-4-2	±6kV: Contact ±8kV: Air	±6kV: Contact ±8kV: Air	Floors should be wood, concrete or ceramic tile. If floors are covered with synthetic material, the relative humidity should be at least 30 %.
Electrical fast transition/burst IEC 61000-4-4	±2kV: Power supply lines ±1kV: Input/output lines	±2kV: Power supply lines ±1kV: Input/output lines	Mains power quality should be that of a typical commercial or hospital environment.
Surge IEC 61000-4-5	±1 kV differential mode ±2 kV common mode	±1 kV differential mode ±2 kV common mode	Mains power quality should be that of a typical commercial or hospital environment.
Voltage drops, dips, and fluctuations of input power supply line IEC 61000-4-11	<5 % <i>UT</i> (>95 % dip in <i>UT</i>) for 0,5 cycle 40 % <i>UT</i> (60 % dip in <i>UT</i>) for 5 cycles 70 % <i>UT</i> (30 % dip in <i>UT</i>) for 25 cycles <5 % <i>UT</i> (>95 % dip in <i>UT</i>) for 5 sec	<5 % <i>UT</i> (>95 % dip in <i>UT</i>) for 0,5 cycle 40 % <i>UT</i> (60 % dip in <i>UT</i>) for 5 cycles 70 % <i>UT</i> (30 % dip in <i>UT</i>) for 25 cycles <5 % <i>UT</i> (>95 % dip in <i>UT</i>) for 5 sec	Mains power quality should be that of a typical commercial or hospital environment. If the user of the ACCUNIQ BC300 requires continued operation during power mains interruptions, it is recommended that the ACCUNIQ BC300 be powered from an uninterruptible power supply or a battery.

Magnetic field of commercial frequency (50/60Hz) IEC 61000-4-8	3 A/m	3 A/m	Power frequency magnetic fields should be at levels characteristic of a typical location in a typical commercial or hospital environment.
---	-------	-------	---

Note	
	<i>U_T</i> is the a.c. mains voltage prior to application of the test level.

3) Guidance and manufacturer's declaration – electromagnetic immunity 2

The ACCUNIQ BC300 is intended for use in the electromagnetic environment specified below. The customer or the user of the ACCUNIQ BC300 should assure that it is used in such an environment.

Immunity test	IEC 60601 test level	Compliance level	Electromagnetic environment-guidance
Conducted RF IEC 61000-4-6	3 Vrms 150 kHz to 80 MHz	3 Vrms	<p>Portable and mobile RF communications equipment should be used no closer to any part of the ACCUNIQ BC300, including cables, than the recommended separation distance calculated from the equation applicable to the frequency of the transmitter.</p> <p>Recommended separation distance</p> $d = 1.2\sqrt{P}$ $d = 1.2\sqrt{P} \quad 80 \text{ MHz to } 900 \text{ MHz}$ $d = 2.3\sqrt{P} \quad 900 \text{ MHz to } 2,5 \text{ GHz}$
Radiated RF IEC 61000-4-3	3 V/m 80 MHz to 2,5 GHz	3 V/m	<p>where P is the maximum output power rating of the transmitter in watts (W) according to the transmitter manufacturer and d is the recommended separation distance in meters (m).</p> <p>Field strengths from fixed RF transmitters, as determined by an electromagnetic site survey,^a should be less than the compliance level in each frequency range.^b</p> <p>Interference may occur in the vicinity of equipment marked with</p>

			the following symbol: 
--	--	--	---

Note	<p>1. At 80 MHz and 900 MHz, the higher frequency range applies.</p> <p>2 These guidelines may not apply in all situations. Electromagnetic propagation is affected by absorption and reflection from structures, objects and people.</p> <p>^a Field strengths from fixed transmitters, such as base stations for radio (cellular/cordless) telephones and land mobile radios, amateur radio, AM and FM radio broadcast and TV broadcast cannot be predicted theoretically with accuracy. To assess the electromagnetic environment due to fixed RF transmitters, an electromagnetic site survey should be considered. If the measured field strength in the location in which the ACCUNIQ BC300 is used exceeds the applicable RF compliance level above, the ACCUNIQ BC300 should be observed to verify normal operation. If abnormal performance is observed, additional measures may be necessary, such as reorienting or relocating the ACCUNIQ BC300.</p> <p>^b Over the frequency range 150 kHz to 80 MHz, field strengths should be less than 3 V/m.</p>
	

4) Recommended separation distances between portable and mobile RF communications equipment and the ACCUNIQ BC300

The ACCUNIQ BC300 is intended for use in an electromagnetic environment in which radiated RF disturbances are controlled. The customer or the user of the ACCUNIQ BC300 can help prevent electromagnetic interference by maintaining a minimum distance between portable and mobile RF communications equipment (transmitters) and the ACCUNIQ BC300 as recommended below, according to the maximum output power of the communications equipment.

Rated maximum output power of transmitter W	Separation distance according to frequency of transmitter m		
	150 kHz to 80 MHz $d = 1.2\sqrt{P}$	80 MHz to 900 MHz $d = 1.2\sqrt{P}$	900 MHz to 2,5 GHz $d = 1.2\sqrt{P}$
0.01	0.12	0.12	0.23
0.1	0.38	0.38	0.73
1	1.2	1.2	2.3
10	3.8	3.8	7.3
100	12	12	23

For transmitters rated at a maximum output power not listed above, the recommended separation distance d in meters (m) can be estimated using the equation applicable to the frequency of the transmitter, where P is the maximum output power rating of the transmitter in watts (W) according to the transmitter manufacturer.

Note



1. At 80 MHz and 900 MHz, the separation distance for the higher frequency range applies.
2. These guidelines may not apply in all situations. Electromagnetic propagation is affected by absorption and reflection from structures, objects and people.

ABOUT BODY COMPOSITION

1. Body Composition

Human body consists of body fat and lean body. Lean body means non-fat constituents of human body like body water, muscles, bones, etc.

Body water is divided into intra- and extra-cellular water and the ratio between them is controlled and maintained within a certain range. Body fat is piled beneath the skin and between abdominal organs. Body fat is hydrolyzed to make energy needed to normal physiological function when energy supply through food intake is not sufficient, but excessive fat in the body itself is a kind of disease and causes lifestyle diseases.

Healthy people maintain the balance of body composition in a steady proportion but unhealthy people persons fail to keep this balance. When the balance in body composition is broken, diseases like obesity, malnutrition, osteoporosis, etc. can be caused.

2. Obesity

Various methods can be used to assess obesity but the key factor in obesity assessment is the amount of fat accumulated in the body.

In general, obesity is defined as the state of not only excessive weight compared with height (visible obese) but also excessive body fat compared with weight (invisible or visible obese).

Strictly speaking obesity is the state that body fat occupies considerably high ratio to weight.

3. Necessity of Body Composition Analysis

Body Composition Analysis is a good indicator to find possible health problems. Body composition analysis enables professionals to find obesity or imbalance in body composition at early stage and helps subjects keep their body healthy. Body composition analyzer is a useful preventive diagnostic device.

4. Waist to hip ratio

Waist to hip ratio (W.H.R.) shows the distribution of fat stored in one's abdomen and hip. It is simple but useful to assess body fat distribution. Body fat is stored in two distinct ways. They are often called 'apple' and 'pear' type. Apple type shows bigger girth of waist than hip and pear type has bigger girth of hip than waist. If body fat in abdomen increases more, the risk to cardiovascular diseases, diabetes, etc. becomes higher.

5. Abdominal Fatness

Body fat is divided into subcutaneous fat and visceral fat. Visceral obesity is considered to be a critical risk factor along with Percent of body fat.

Lipoprotein lipase can be easily activated in visceral fat, and it cause visceral fat to be dissolved easily. Dissolved visceral fat goes into liver through the vessel and it cause fatty liver or increasing lipid in the blood. It also elevates the risk of hyperinsulinemia, hypertension, and cardiovascular disease.

Visceral fat generally occupies 10 ~ 20 % of body fat, and visceral obesity is assessed based on the indicators below.

- the cross sectional fat area between L4 ~ L5 is 100 cm² and over
- the visceral fat to subcutaneous fat ratio is 0.4 and over
- the waist to hip ratio (W.H.R.) is over 0.9 (male) / 0.85 (female)
- the circumference of waist is over 102 cm (male) / 88 cm (female)

Visceral fat increases after their 30s in men and after Menopause in women. It is more common in men than women and the old than the young. Visceral fat tends to increase with aging. Because the combustion rate per minute of visceral fat is higher than that of subcutaneous fat, visceral fat can be easily reduced by exercise or dietary control in case of abdominal obesity. W.H.R. is the ratio of waist to hip circumference and has relation to one's figure.

6. Segmental Analysis

This device analyzes soft lean mass of five body parts; trunk, right arm, left arm, right leg, and left leg. This function can be used as an assessment tool to evaluate the result of exercise or rehabilitation treatment.

7. Age Matched of Body

It is the estimated physical age of the subject considering body composition analysis result, gender, and biological age. This is calculated by comparing the optimal body composition based on the gender and biological age of the subject with the actual analyzed body composition. It can be used to evaluate the subject's health and body development.

TERM AND FUNCTION OF EACH PART

1. Main Body

1) Front Part



- Color LCD screen
It displays the procedure and results.
- Handle Electrode
Handle Electrode measure the impedance by sending harmless electric current to the body.
Hold them with the hands during measurement.
- Key pad
Key pad consist of numeric buttons from 0 to 9, alphabet, 'ID', 'ID', 'ID', '.', 'CE', '<', '>', 'BACK', and 'NEXT'.
- Thermal Printer (Option)
Thermal printer allows the speedy and convenient printing.

2) Rear Part

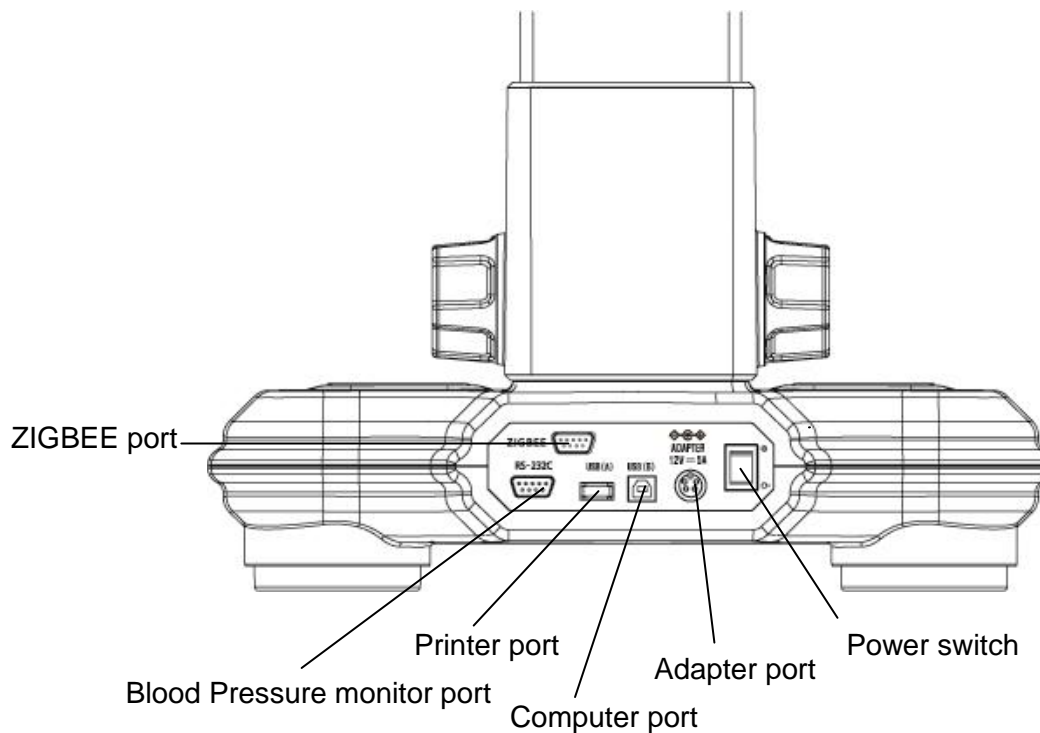

- Blood pressure monitor (RS-232C) port: Connecting blood pressure monitor (OPTION) by SELVAS Healthcare, Inc.
- Printer (USB(A)) port: Connecting the printer offered with this device.
- Computer (USB(B)) port: Connecting a computer.
- Adapter port (ADAPTER): Connecting an adapter.
- Power switch: It can be used to turn on/off the power.
- ZIGBEE port: In case of using wireless communication with computer, it can be used to connect ZIGBEE (Wireless communication). Wireless connecting is possible with Body Pass Plus or Easy Body Plus. (Wireless communication – Option)
When you choose a height meter as option, it will be connected to ZIGBEE port. It is impossible to use both ZIGBEE (Wireless communication) and height meter. When height meter is connected, you can not use wireless communication.

3) Base Part

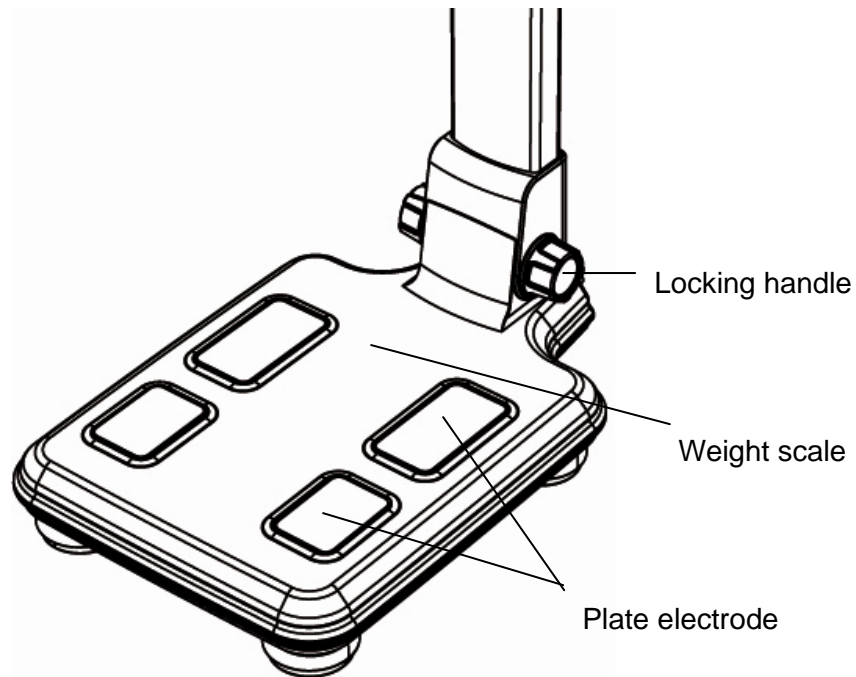

- Locking handle: When transport is necessary, the column can be folded down by turning the screw counterclockwise. During this process, hold the column with one hand and turn the screw with another hand.
- Weight scale: It is equipped with plate electrodes and measures weight.
- Plate electrode: Impedance is measured from these plate electrodes. The user should step them in bare feet.

4) Bottom of the head part

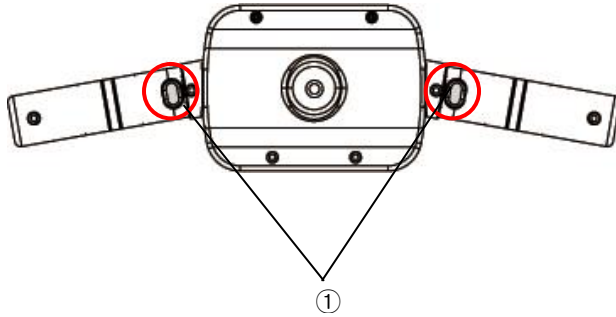

① Start button: Start button after input of personal data

Note





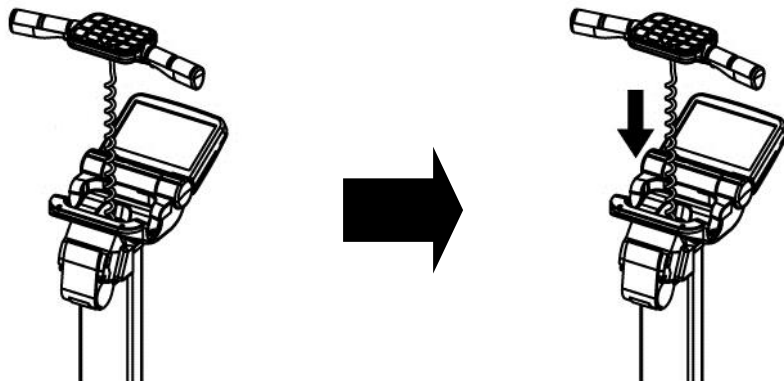



- Head part is connected to main body by limited-length curl cord. It allows measuring people in 100 – 200 cm height.
- After the measurement, return the head to the original position.
- For accurate measurement, lift the head up after turning on the power and measuring weight.



5) Key Pad



-  button: When you press this button at initial screen, you can search ID and check the recent results of searched ID. Print the result with PRINT button.
-  button: You can select gender; male or female.
-  button: You can print out the result sheet.
- Number 1~9, alphabet button: You can input ID using this button.
(ex: If you want to input number '1', press  button 4times: 1→A→B→C)
-  Button: You can delete one letter when entering ID.
You can put • when entering height.
-  Button: You can enter 0 and give a space while entering ID.
You can input 0 when entering age and height.
-  Button: You can delete entered ID or whole data.

2. Basic Package

Basic package of this product is composed of

- ① Main body
- ② User guide
- ③ Body composition management program (CD)
- ④ A4 Result Sheet
- ⑤ USB cable
- ⑥ Power cable and adapter

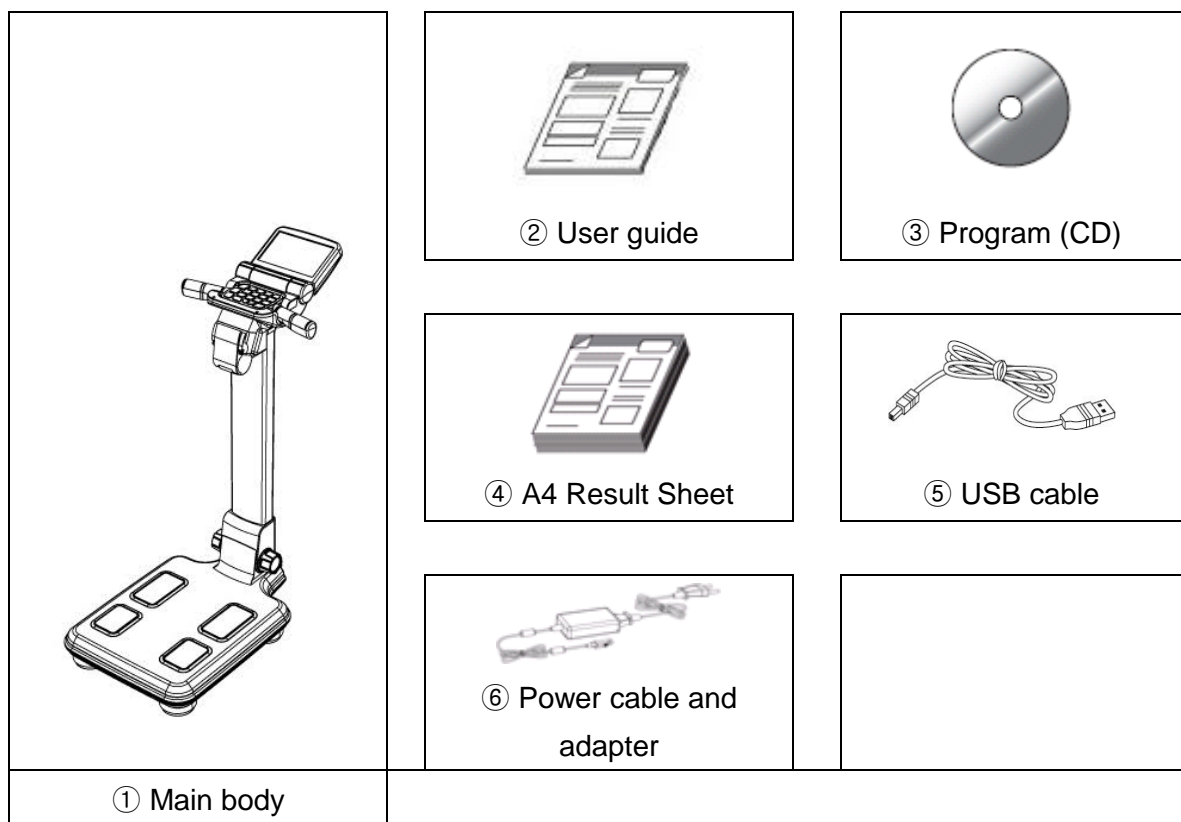

※ The model or specification are subject to change according to the market demand.

3. Options

1) Automatic Blood Pressure Monitor

If SELVAS's automatic blood pressure monitor for hospital is connected to this device, the measurer can easily check his/her blood pressure. Especially the patient with the hypertension can manage his/her blood pressure efficiently through body weight control.

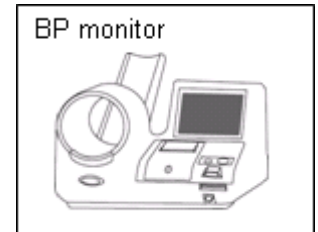

2) Thermal Printer

Thermal printer allows the speedy and convenient printing.

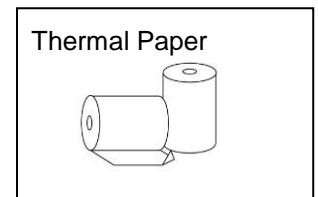

3) Thermal Paper

Measured result is presented in simple and easy way.

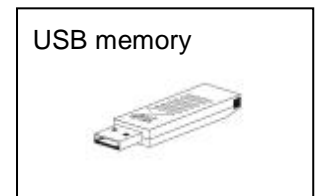

4) USB memory

Speedy and convenient measurement with personal information.

5) Height Meter

This is an instrument to measure subject's height more accurately and quickly. It employs standoff determination method using ultrasonic sensor. Refer to INSTALLATION MANUAL.

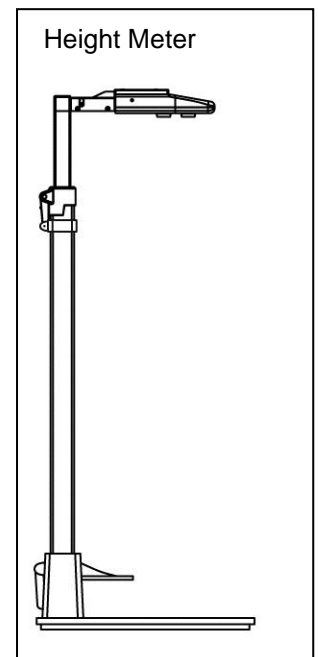

Caution



Optional devices are should be use only from our company.

INSTALLATION

1. Installation of product

- ① Unscrew all screws from the carry bag with screwdriver (attached on the top of the bag).

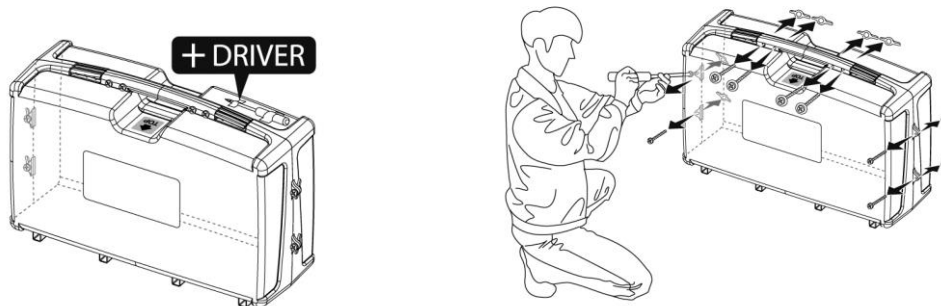

- ② "TOP" mark should be indicated on top of the box when you place the carry bag. Unlock the both handles to open the bag.

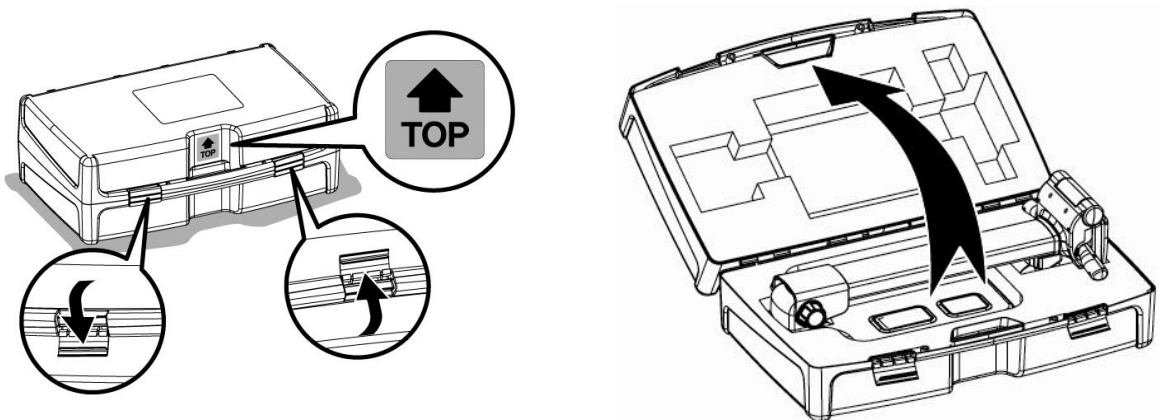

- ③ Put your hands as shown in the picture. Hold the device with both hands and take the device out.

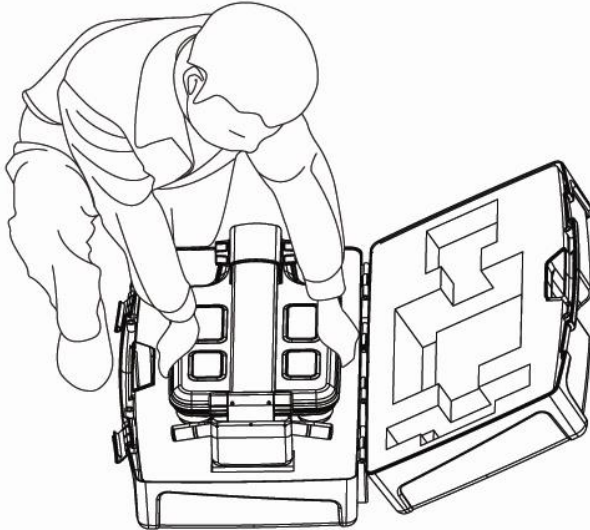

- ④ Place the device on the flat floor. Stand the body part of device with one hand and fix the locking handle by turning it clockwise with another hand.

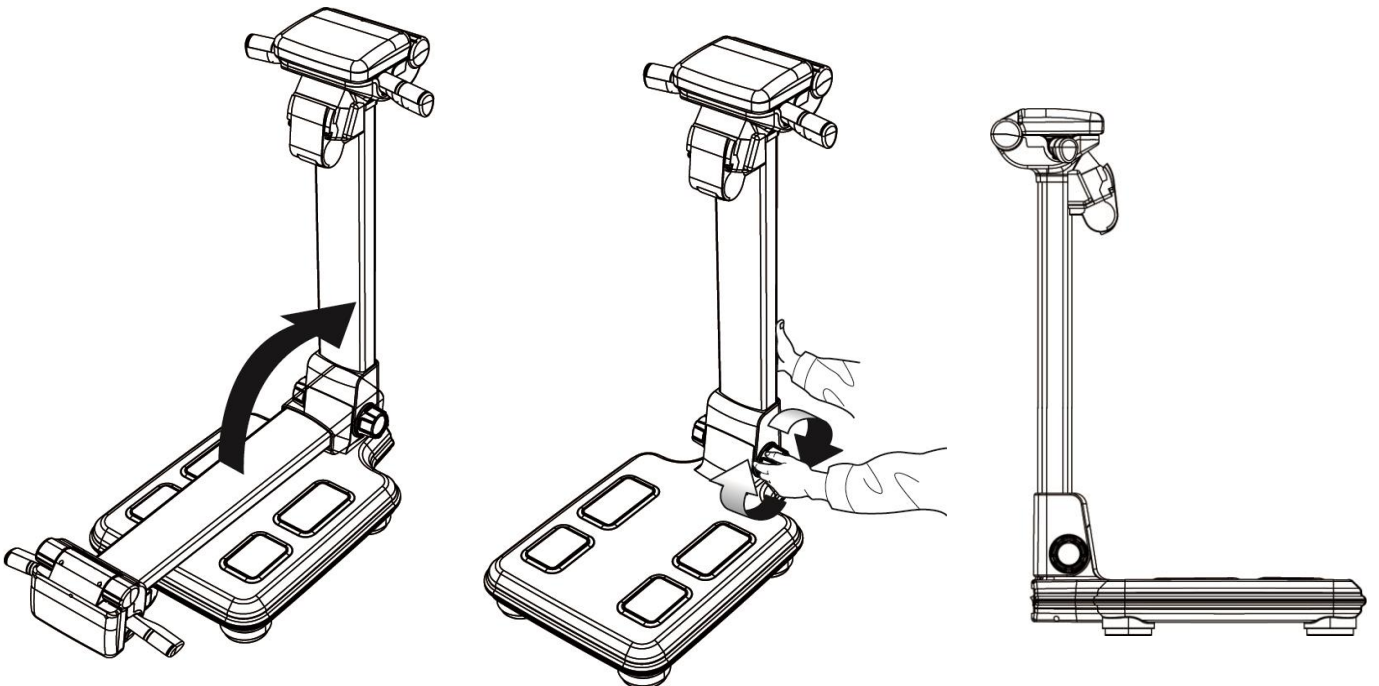

- ⑤ Open LCD and adjust the angle. Connect the power cable.

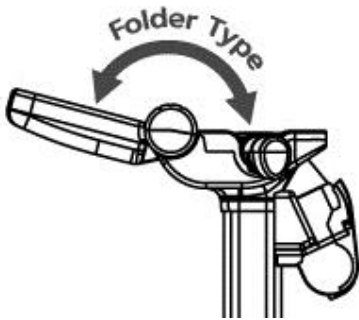

2. Power Supply

Connect the adapter to the adapter jack placed on the rear panel of this device. After the cables are connected to each jack, turn on the power switch placed beside the adapter jack.

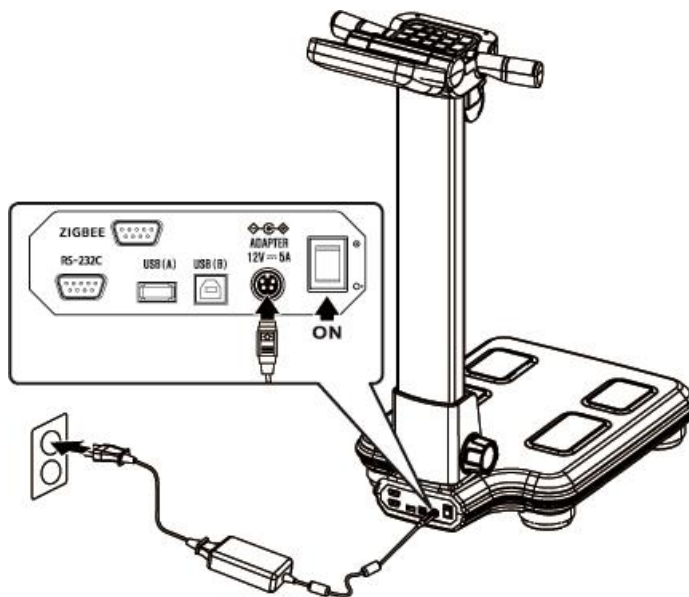

Caution



1. Before connecting a peripheral device to this device, the power should be turned off. Otherwise this device can malfunction or be damaged due to electric shock.
2. Power should be supplied from this device to ensure the safe operation and durable performance.
3. This device should be powered with the adapter and cable supplied only from our company.
4. Be careful not to touch the base part of the device when the power switch is turned ON.
Error occurs to the zero point of the scale.

Caution



When connecting adaptor, place the arrow mark of adaptor connection part up and correctly stick it in the socket on the rear of the main body.

Wrong connection could be a fire hazard.



3. Peripheral Device Installation

1) Connecting Computer

Connect the “USB(B)” port placed on the rear panel of this device to the USB port in computer with USB cable.

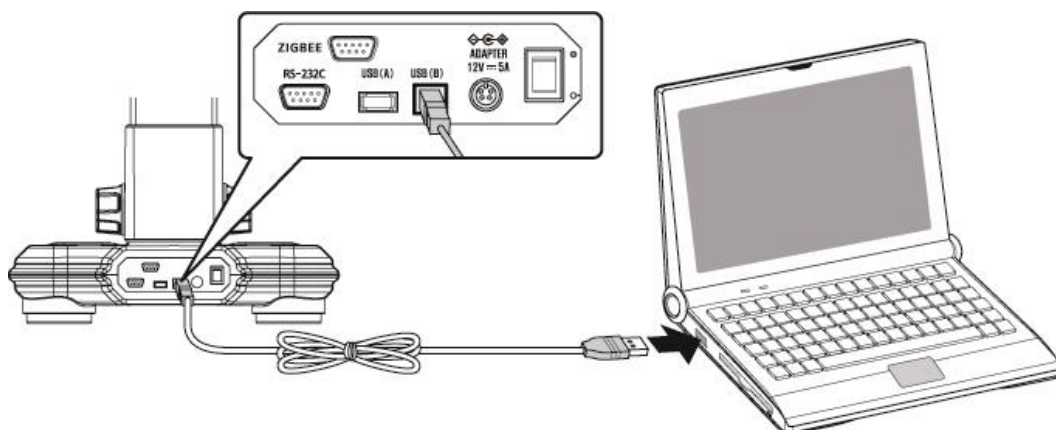

Note



1. In order to save, search, and retrieve subject's data, the device should be connected to PC in which Body Pass Plus is installed. The result sheet can be printed from the printer connected to the PC.
2. Professional consulting software, Easy Body Plus (option) easily assesses and explains body composition analysis. This program helps managing body composition easily and systematically. It can help the measurer to analyze his/her body composition at a glance.
3. For the installation of Body Pass Plus and Easy Body Plus, refer to its User's manual.

2) Connecting Printer

① Connecting the device and the printer directly

Connect A4 printer offered with this device to the “USB(A)” port placed on the rear panel of this device with USB cable.

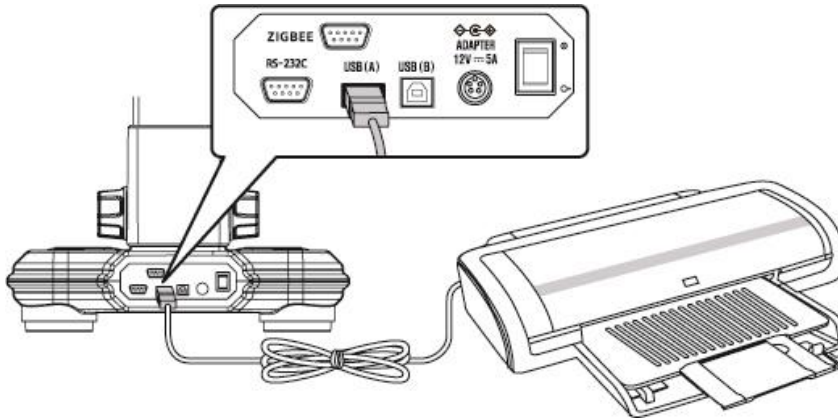

② Connecting the device, computer, and the printer

Connect a computer to the “USB(B)” jack placed on the rear panel of the device with USB cables. Connect the printer to the computer with printer cable. The result sheet can be printed out from the printer.

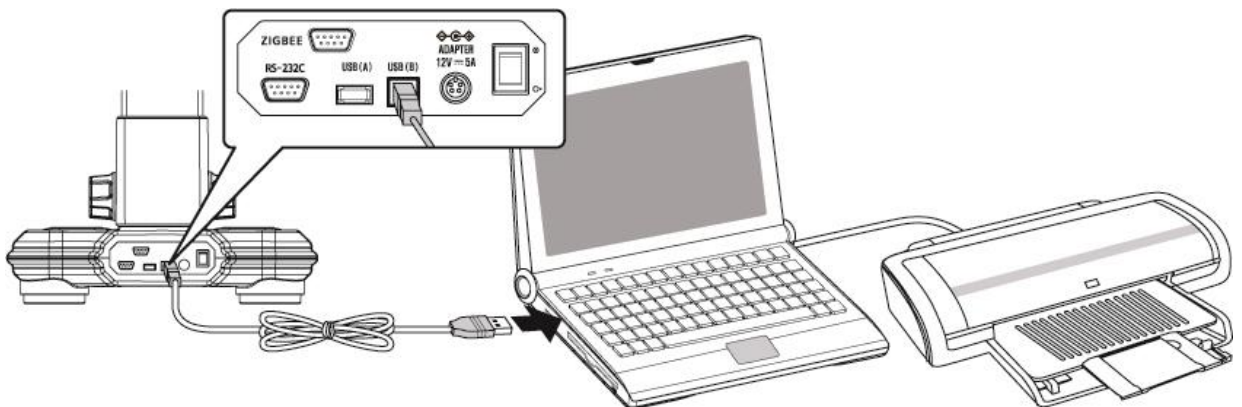

3) Connecting Blood Pressure Monitor

This device is connectable with automatic blood pressure monitor of our company. (Option)
Connect a blood pressure monitor to “BLOOD PRESSURE(RS-232C)” port placed on the rear panel of this device with blood pressure monitor cable.

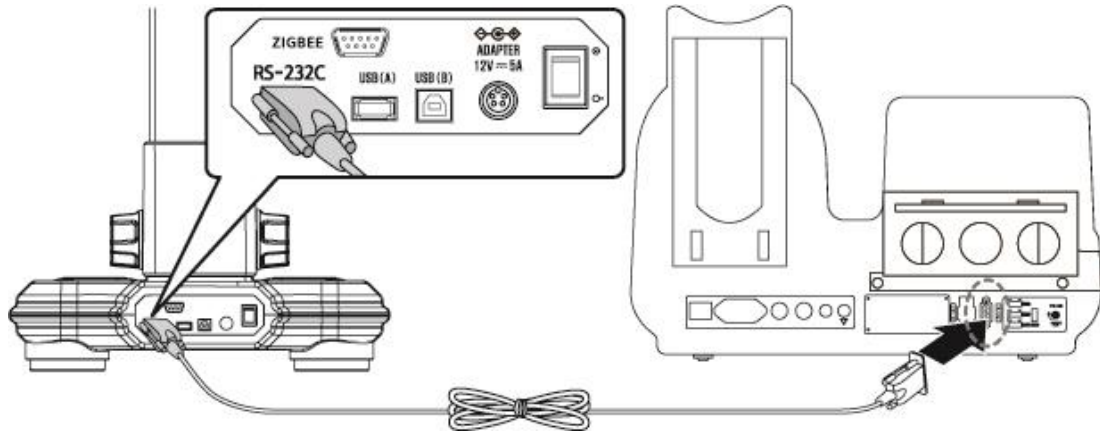

4) Replacing of thermal paper (Option)

Replace thermal paper while the power is on.

- ① Turn the screws counterclockwise and open the cover as shown in the picture.
- ② Insert the thermal paper to the direction as shown in the picture.
- ③ Slightly insert the edge of thermal paper to the printer slot. Thermal paper will be printed out and it automatically cuts out.
- ④ Close the cover and fix the printer cover by turning the screws clockwise.

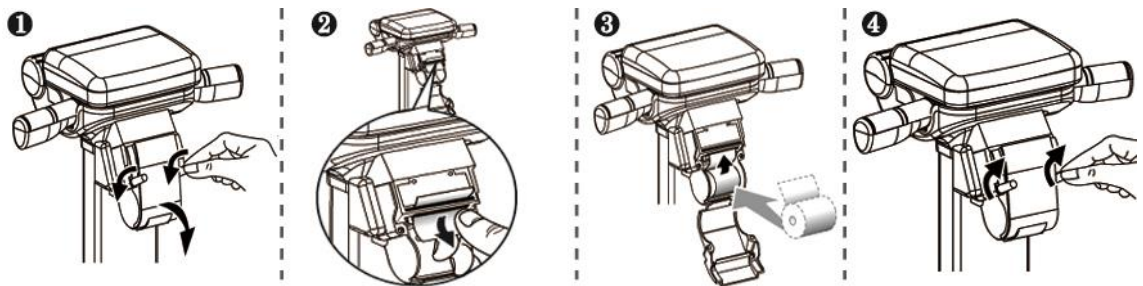

4-1) FEED/CUT functions of thermal printer

• FEED Function

Press '0' button 5 times at initial screen.

Press 'PRINT' button to print the thermal paper.



• CUT Function

Press 'CUT' button 5 times at initial screen.

Press 'PRINT' button to cut the thermal paper.



Note



Do not pull thermal paper while printing. Paper will be cut automatically when printing is completed.

SYSTEM SETUP

SYSTEM SETUP allows users to change the setting of operational parameters.

Note



The contents in SYSTEM SETUP can be changed for improvement.

1. Entering SYSTEM SETUP

At the initial screen, press '◀ → 1 → 2 → 3 → 4 → ▶' button in key pad to enter 'SYSTEM SETUP' screen.

2. Menu in SYSTEM SETUP

Menu items are displayed. The function of each icon is as follows.

- | | |
|-------------------|-----------------------------|
| 1. DATE / TIME | 8. DATE TYPE |
| 2. VOLUME | 9. THERMAL PRINT |
| 3. PRINT | 10. Wireless communication |
| 4. PRINT POSITION | 11. ID usage |
| 5. CLOTHES | 12. Abdominal Circumference |
| 6. SCALE OFFSET | 13. GUIDE |
| 7. ABD. FATNESS | 14. CHILD/ADULT/AUTO |
| | 15. HEIGHT METER |



3. Selecting a Menu in SYSTEM SETUP

Select the menu by pressing '◀' and '▶' button.

Press BACK button in key pad.

(BACK button act as 'SET' button in SYSTEM SETUP and NEXT button act as 'CLOSE' button.)



4. Exiting SYSTEM SETUP

Press NEXT button on SYSTEM SETUP screen.
Initial screen will appear.



5. Moving to SYSTEM SETUP

Press NEXT button on selected menu screen.
SYSTEM SETUP screen will appear.

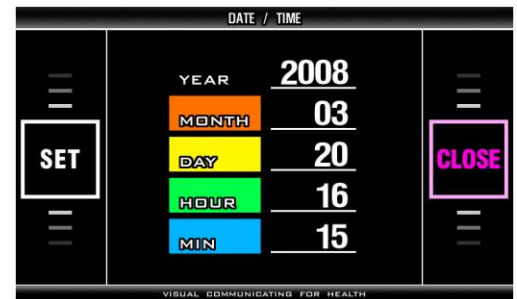

6. Setup

< DATE / TIME >

It is to set date and time (year, month, day, hour, and minute).

- Select  (DATE / TIME) on SYSTEM SETUP screen with '◀' and '▶' button and press BACK button in key pad.
- Pre-set: The date of the device released from the manufacturer's factory.
- Choose YEAR by pressing '1' in key pad.
- Set the number with '◀' and '▶' button in key pad.
- Choose MONTH by pressing '2' in key pad. Set correct date and time in the same way.
- 3- DAY, 4-HOUR, 5-MIN
- Press BACK button in key pad to save date and time.
- Return to SYSTEM SETUP screen by pressing NEXT button in key pad.

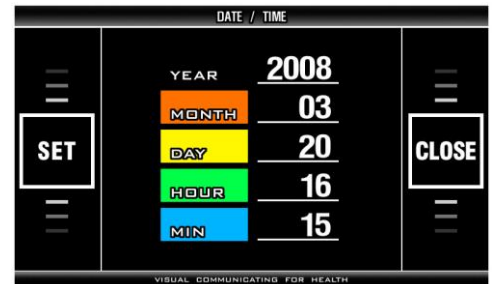

Note



1. If 'BACK' button is pressed before finishing setup of date and time, the date and time inputted at that time is saved and SYSTEM SETUP screen appears. To cancel any changes attempted, press 'CLOSE' then this device saves the previous date and time and SYSTEM SETUP screen appears.
2. When Body Pass Plus or Easy Body Plus is used in data management, measured date is automatically saved as the date set in this device. Therefore the date and time set in this device should be checked before use.

< VOLUME >

It adjusts the volume of voice guidance.

- Select  (VOLUME) on SYSTEM SETUP screen with '◀' and '▶' button and press BACK button in key pad.
- Pre-set: 3
- Range: 0 ~ 9
- Adjust volume with '◀' and '▶' button in key pad.
- Press BACK button in key pad to save selected value.
- Return to SYSTEM SETUP screen by pressing NEXT button in key pad.

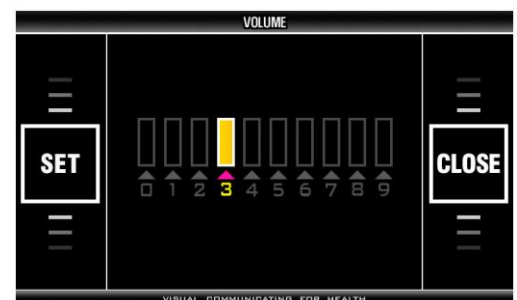

< PRINT >

It selects the printing mode of the A4 printer.

- Select  (PRINT) on SYSTEM SETUP screen with '◀' and '▶' button and press BACK button in key pad.
- Pre-set: AUTO
- Choose one with '◀' and '▶' button in key pad.
- Press BACK button in key pad to save it.
- Return to SYSTEM SETUP screen by pressing NEXT button in key pad.



< PRINT POSITION >

It adjusts the printing position in the direction of U-D (up-down) and L-R (left-right) to fit to the pre-formatted result sheet.

- Select  (PRINT POSITION) on SYSTEM SETUP screen with '◀' and '▶' button and press SET button in key pad.
- Pre-set: 00 for U-D and 00 for L-R
- Range: 99 for U-D and 99 for L-R
- Choose "BCA" by pressing '1' in key pad. Choose "CHD" by pressing '2' in key pad.
- Choose U-D by pressing '3' in key pad. Choose L-R by pressing '4' in key pad.
- Pressing ▶ button moves print position down or right.
- Pressing ◀ button moves print position up or left.
- Every single press moves print position by about 0.2 mm.
- Press BACK button in key pad to save it.
- Return to SYSTEM SETUP screen by pressing NEXT button in key pad.

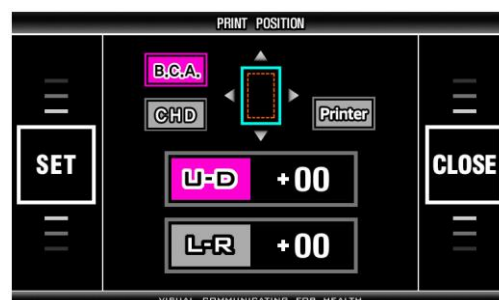

Note



1. L-R (left-right): - is moving to the left and + is moving to the right.
U-D (up-down): - is moving up and + is moving down.
2. The print position needs to be separately set on the result sheet for Body composition analysis and result sheet for children each.
Press "BCA" and adjust the print position of Body composition analysis result sheet and then press 'BACK' button to save the setting.
Press "CHD" and adjust the print position of result sheet for children and then press 'BACK' button to save the setting.
3. Print test
When you press "Print" button, you can print the test page of BCA or CHD.

< CLOTHES >

It is to subtract the weight of clothes worn by the subjects from measured weight. Calculated value from this setting is used in body composition analysis as subject's weight.

- Select  (CLOTHES) on SYSTEM SETUP screen with '◀' and '▶' button and press BACK button in key pad.
- Pre-set: 0.0 kg
- Range: 0 ~ - 9.9 kg
- Set the value with '◀' and '▶' button in key pad.
- Every single press changes this value by 0.1 kg.
- Press BACK button in key pad to save it.
- Return to SYSTEM SETUP screen by pressing NEXT button in key pad.



< SCALE OFFSET >

It compensates measured weight. Calculated value from this setting is used in body composition analysis.

- Select  (SCALE OFFSET) on SYSTEM SETUP screen with '◀' and '▶' button and press BACK button in key pad.
- Pre-set: 0.0 kg
- Range: -9.9 ~ +9.9 kg
- Set the value with '◀' and '▶' button in key pad.
- Every single press changes the value by 0.1 kg.
- Press BACK button in key pad to save it.
- Return to SYSTEM SETUP screen by pressing NEXT button in key pad.

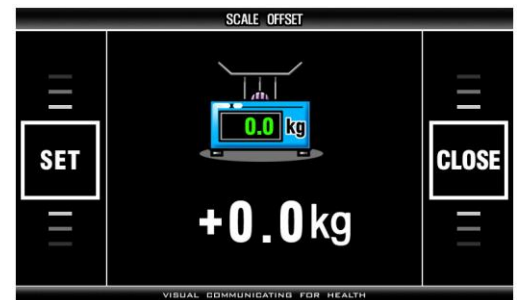

< ABDOMINAL FATNESS >

It is to set whether to use abdominal analysis or not.

- Select  (abdominal fatness) on SYSTEM SETUP screen with '◀' and '▶' button and press BACK button in key pad.
- Pre-set: NO
- Choose YES or NO with '◀' and '▶' button in key pad.
- If YES is chosen, abdominal analysis is performed to all age.
- If NO is chosen, abdominal analysis won't be displayed to the person below 18 years old.
- Press BACK button in key pad to save it.
- Return to SYSTEM SETUP screen by pressing NEXT button in key pad.



< DATE TYPE >

It is to set a display format of date.

- Select  (DATE TYPE) on SYSTEM SETUP screen with '◀' and '▶' button and press BACK button in key pad.
- Pre-set: YY-MM-DD
- Choose one with '◀' and '▶' button in key pad.
- Press BACK button in key pad to save it.
- Return to SYSTEM SETUP screen by pressing NEXT button in key pad.

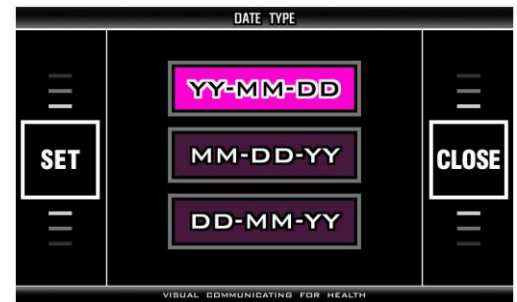

< THERMAL PRINT >

It is to choose printing mode of thermal printer. (Thermal printer is option.)

- Select  (THERMAL PRINT) on SYSTEM SETUP screen with '◀' and '▶' button and press BACK button in key pad.
- Pre-set: OFF
- Choose 'AUTO' or 'MANUAL' or 'OFF' with '◀' and '▶' button in key pad.
- Press BACK button in key pad to save it.
- Return to SYSTEM SETUP screen by pressing NEXT button in key pad.



< Communication >

Select the connecting method between ACCUNIQ BC300 and a computer. 'CABLE' is for USB cable and 'WIRELESS' is for wireless communication.

- Select  (COMMUNICATION) on SYSTEM SETUP screen with '◀' and '▶' button and press BACK button in key pad.
- Preset: CABLE
- Choose CABLE or WIRELESS with '◀' and '▶' button in key pad.
- Press BACK button in key pad to save it.
- Return to SYSTEM SETUP screen by pressing NEXT button in key pad.

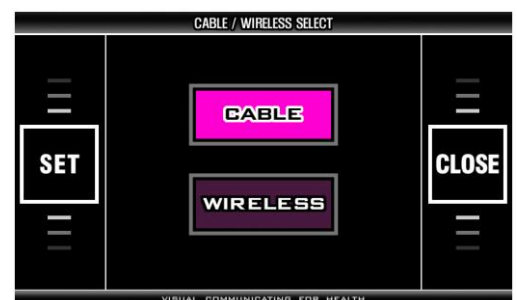

< ID usage >

It is set to whether to use ID or not.

- Select  (ID usage) on SYSTEM SETUP screen with '◀' and '▶' button and press BACK button in key pad.

- Preset: ID usage-NO,

SAVE DEVICE-FLASH MEMORY

- ID USAGE: Choose ID USAGE by pressing '1' in key

pad. Choose YES or NO with '◀' and '▶' button in key pad.

- SAVE DEVICE: Choose SAVE DEVICE by pressing '2' in key pad. Choose FLASH MEMORY or USB MEMORY with '◀' and '▶' button in key pad.

- If you use ID, ID can be entered in 20-digits and saved in FLASH memory or USB memory.

- Press BACK button in key pad to save it.

- Return to SYSTEM SETUP screen by pressing NEXT button in key pad.

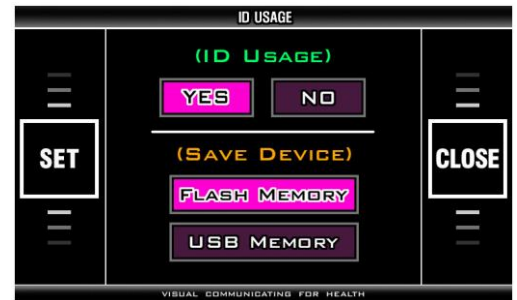

Note



1. If ID function is activated, ID window will pop up at the initial screen. So the user can input ID and save the results. If ID function is not activated, the user should input basic information before the test starts and the result is not saved.
2. If FLASH MEMORY is selected, the results are saved in flash memory in the machine itself. If USB MEMORY is selected, the results are saved in portable USB memory stick.

Note



1. When FLASH MEMORY is used,
 - ① The result can be saved up to 1000. If the number of saved results exceeds 1000, the new result will be overwritten from the oldest result. The results can be deleted and initialized.
 - ② The result sheet can be printed from A4 printer and thermal printer.
2. When USB MEMORY is used,
 - ① It is possible to save over 1000 results. The number of storage is different depending on the capacity of USB MEMORY.
 - ② The result sheet can be printed only from thermal printer.
3. The user should use USB memory (option) supplied only from our factory. The functional problems can be occurred by connection problem.

< Abdominal Circumference >

It displays abdominal circumference.

- Select  (Abdominal Circumference) on SYSTEM SETUP screen with '◀' and '▶' button and press BACK button in key pad.
- Preset: YES
- Choose YES or NO with '◀' and '▶' button in key pad.
- Press BACK button in key pad to save it.
- Return to SYSTEM SETUP screen by pressing NEXT button in key pad.

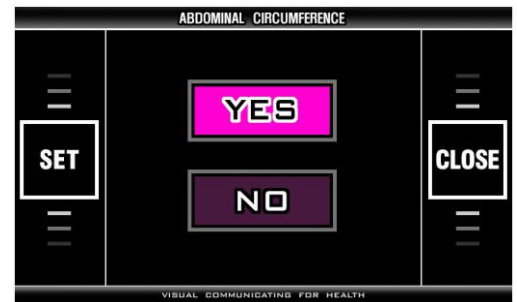

<GUIDE>

This is to display guide screen.

- Select  (Guide) on SYSTEM SETUP screen with '◀' and '▶' button and press BACK button in key pad.
- Preset: YES
- Choose YES or NO with '◀' and '▶' button in key pad.
- Press BACK button in key pad to save it.
- Return to SYSTEM SETUP screen by pressing NEXT button in key pad.
- When GUIDE is set with 'YES', guide screen will be displayed to help the user. It showed up when the head part is lifted up after measuring weight.
- When set with 'NO', personal information, input screen will be indicated right after measuring weight.

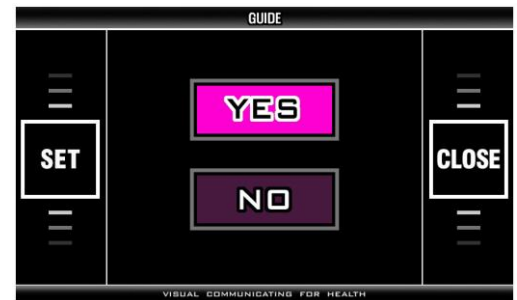

<CHILD/ADULT/AUTO>

It selects the print format of result sheet.

- Choose  on SYSTEM SETUP screen with '◀' and '▶' button and press BACK button in key pad.
- Pre-set: AUTO
 - Select a print format with '◀' and '▶' button
 - Press BACK button in key pad to save it.
 - Return to SYSTEM SETUP screen by pressing NEXT button in key pad.



Note



1. The print format of result sheet

- ① CHILD: No matter what age is set, it prints the result sheet for CHILD.
Only the child growth curve is not printed in case of 18 or over 18.
- ② ADULT: No matter what age is set, it prints the result sheet for ADULT.
The child growth percentile is presented on the ADULT result sheet in case of under 18.
- ③ AUTO: It automatically selects and prints a CHILD result sheet in case of under 18 and an ADULT result sheet in case of 18 or over 18.

<HEIGHT METER>

Adjust the height meter and select use of height meter.

- Preset: 000.0cm, OFF

- Adjustable range: ± 99.9 cm

- Select  (HEIGHT METER) to enter menu screen.

- Set the height meter adjustment value by '◀', '▶' button in keypad.

- Press "2" on keypad and then select 'YES' or 'NO' by '◀', '▶' button in keypad.

- Press 'BACK' button to complete setup. Press 'NEXT' button to return to the initial screen of 'SYSTEM SETUP'.



Note



1. Height meter is an option.

2. Activate the use of height meter in 'SYSTEM SETUP' when you connect height meter.

3. If height meter is not connected, "Height meter is not connected, move to height input mode" message will be appeared.

Check the cable which connects the height meter to the device.

If message above appears while height meter is connected, please ask us or appointed agent.

MEASUREMENT AND ANALYSIS

1. Precautions for Measurement

The reliability of the results can be assessed by its accuracy. The "Accuracy" of the device is determined by comparing the actual body composition and the results from Body Composition Analyzer. The "Reproducibility" is determined when the device gives the identical results under the same condition. In order to maintain the accuracy of the results, the following guidelines should be kept.

- ① Water volume increases after a meal. Therefore, measure on an empty stomach.
 - Measure 3 ~ 4 hours after a meal.
 - Avoid the beverages containing caffeine or the beverages functioning as diuretics 4 hours before the measurement.
 - Drink 2 cups of water 2 hours before the measurement.
- ② Before the measurement, the subject should be in a stable condition.
 - Measure 3 ~ 4 hours after a bath, a sauna, exercise or activity that sweats a lot.
 - Or measure before these actions.
- ③ Avoid drinking alcohol 24 hours before the measurement
- ④ Wear clothes as light as possible.
- ⑤ Once the subject is on the scale, avoid sudden movement from sitting to standing position. Body fluid goes down to the lower body and it affects the results. Thus subjects should be measured after maintaining standing position for 5 minutes.
- ⑥ Clean both the electrodes and measuring body parts.
- ⑦ Changes in room temperature may affect the results. Measurement should be done in a temperature around 20 °C.
- ⑧ Body composition and weight varies even during a day. Therefore, the measurement should be performed at the same time every day. For a person who stands for a long period of time during a day, it is advised to measure in the morning.
- ⑨ Go to bathroom before measurement.
- ⑩ Maintain correct position and posture during the measurement.

In order to keep one's health and the balance of body composition, check the changes of body composition through the continuous analysis and compare the results. Make sure that the body composition should be measured under the same physical and environmental conditions. If the condition before the measurement such as volume of a meal, meal time, and activities (exercise, sauna, drinking lots of beverage, urination, etc.) are kept same, the reproducibility of a device is obtained. Therefore, the data can be used to evaluate the change of body composition.

2. Correct Posture

1) How to Touch Plate Electrodes

- Make sure plate electrodes are clean.
- Take off socks or stockings and then stand on the plate electrodes.
- Remove sweat or foreign matters on the soles.
- Fairly place the bare feet on the plate electrodes. Make sure that the clothes are not between the soles and the plate electrodes.

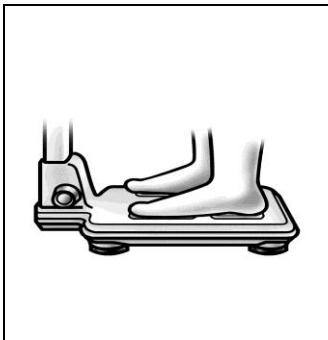

(O) Correct stand

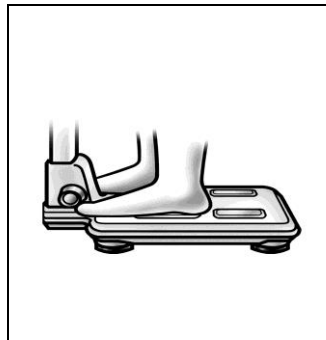

(X) Imbalanced touch

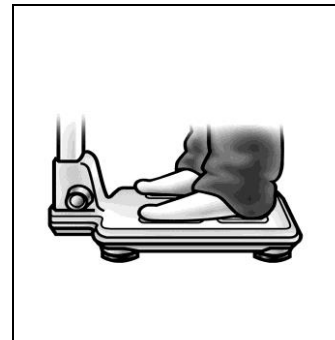

(X) Foreign matters

2) How to Touch Handle Electrodes

- Remove sweat or foreign matters on the hands.
- Grip handle electrodes fairly with fingers and palms. After grab handle electrodes, stretch both arms.



(O) Correct grip

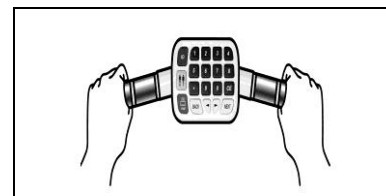

(X) Imbalanced touch

Note



1. When a subject has small hands or feet and cannot cover all electrodes sufficiently, please pay attention to touch all electrodes fairly. How to touch electrodes will affect the reliability of analyzed value.
2. During measurement the subject should not be touched by other person or conductive materials.
3. If all 8 electrodes are not perfectly touched during measurement, measuring will be stopped or the data are not reliable.

3) Measuring Posture

< Correct Posture >



- Step the scale in the bare feet. Stretch both arms and spread them 30° from the body.
- Press start buttons with thumbs for 2 ~ 3 seconds to start the measurement. Once it starts, release the start button and hold the same posture until the measurement is over.
- Do not speak or move the body until the measurement is completed.
- Do not bend or shake the arms until the measurement is completed.
- The measurement will be stopped if all eight electrodes are not fairly touched

3. Measuring Procedure

Available ways to analyze body composition with this device are listed below.

- Basic analysis: Body composition analysis is performed by measuring weight and impedance and inputting height, age and gender.
- Blood pressure analysis: Blood pressure monitor can be connected to the device.
- Analysis using software program: Body composition management software Body Pass Plus or professional counseling software Easy Body Plus can be installed in a computer which is connected to the device.

Note	When the device is connected to a computer in which Body Pass Plus (basic offer) or Easy Body Plus (option) is installed, personal information of a subject should be input in the program first. The saved information will be transferred to the device.
	

1) Basic Analysis

① Weight measurement

- When the subject stands up on the scale, the screen changes with a chime bell.
- Do not move or speak until measurement is completed.
- Measured weight is displayed on the screen after weighing is completed.



- ##### ② After weight measurement, the screen changes as shown in the picture. Hold up the key pad and input necessary information.

When 'GUIDE' menu of SYSTEM SETUP is set with 'NO', guide screen as shown in the right picture is not indicated. Personal information input screen will be displayed.



③ Personal information

Input personal information in the order of ID, height, age, and gender. Confirm the information and press NEXT button.

(If ID usage is selected from 'SYSTEM SETUP', ID screen will be pop-up.)

[ID usage: YES]

- ID input
 - The following message appears.
"Input your ID, please."
ID can be made up to 20 characters including English, number and a space.
 - Press '▶' button.

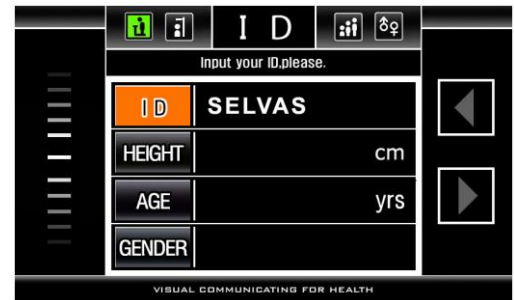

Note



1. If ID is already registered in previous time, input ID and press '▶' button. The data of Height, Gender and age saved in ID automatically appears on the display. The saved data can be changed by pressing '◀', '▶' button.
2. When transmit the member information from Body Pass Plus to the device, ID USAGES screen will appear. In this case, you can not modify personal information such as height, age and gender at the device. Modify the personal information on the program and transmit the member information to the device again.
3. When BARCODE SCANNER is used as an option, ID USAGES screen will appear again. In this case, ID can not be modified. Only personal information such as height, age and gender can be modified.

- Input height
 - "Input your height." appears.
 - Input the subject's height with number buttons in key pad.
 - Press '▶' button.

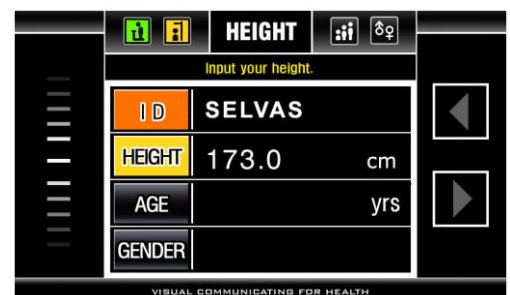

- Input age
 - “Input your age.” appears.
 - Input the subject’s age with number buttons in key pad.
 - Press ‘▶’ button.

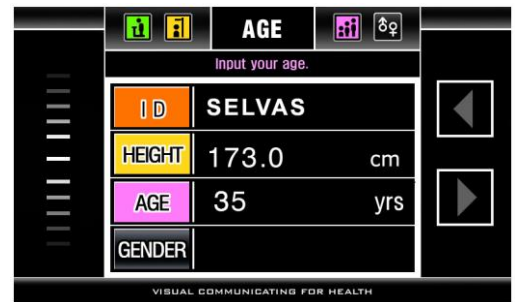

- Gender selection
 - “Select your gender.” appears.
 - Select MALE or FEMALE with Gender button in key pad.
 - After finishing the subject’s personal data input, press NEXT button in key pad.

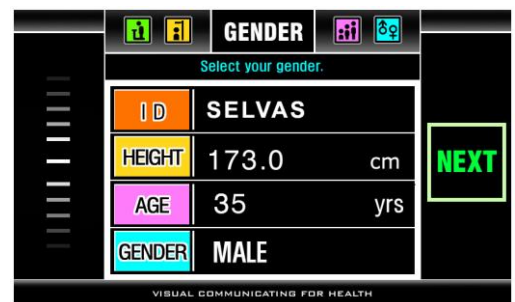

[ID usage: NO]

- Input height
 - “Input your height.” appears.
 - Input the subject’s height with number buttons in key pad.
 - Press ‘NEXT’ button.

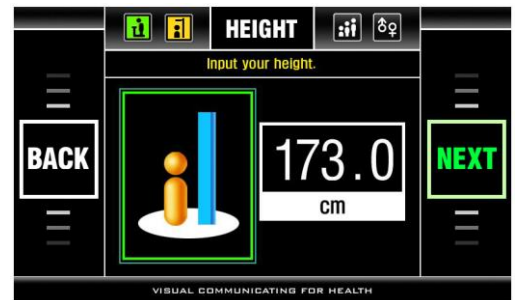

- Age input
 - “Input your age.” appears.
 - Input the subject’s age with number buttons in key pad.
 - Press ‘NEXT’ button.



- Select gender
 - “Select your gender.” appears.
 - Select MALE or FEMALE with Gender button in key pad.
 - Press ‘NEXT’ button.



[Measure height]

If height meter is selected as an option, height meter measurement screen will appear after measuring weight.

- Press NEXT button in key pad.

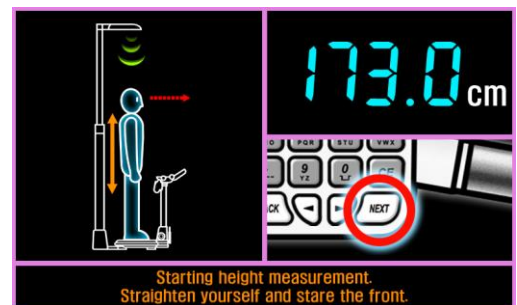

④ Measurement posture 1

After inputting the subject’s personal data, the screen changes as shown in the picture.

- Fit feet on plate electrodes accurately.

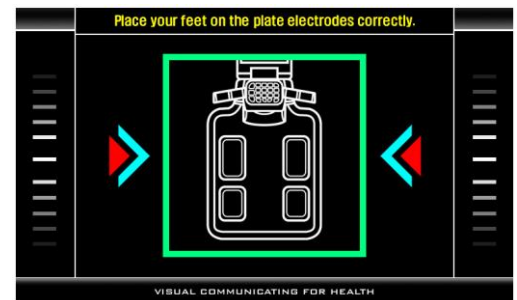

⑤ Measurement posture 2

Stretch both arms and spread them 30° from the body.

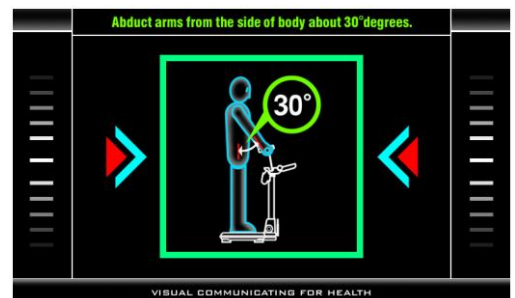

⑥ Measurement posture 3

- Grip handle electrodes correctly and press START buttons with thumbs at the same time.
- Impedance measurement starts by pressing start buttons.
- Do not move or speak during measurement.

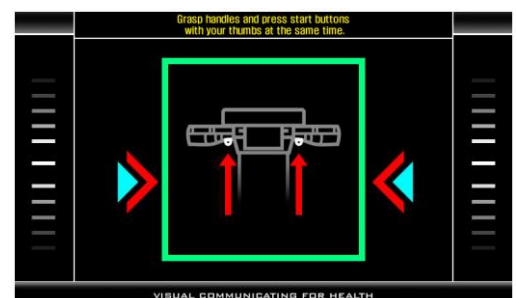

⑦ During the measurement, the following screen appears.

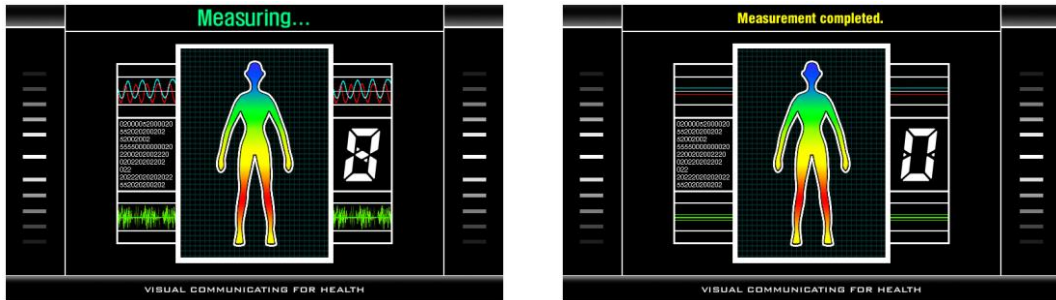

Note



1. Press both start buttons for 2 seconds. Do not move or bend the arms until the measurement is completed. Measuring time is within 1 minute.
2. When the measurement is wrong,
 - Error message appears on the screen.
 - To measure again, hold the handle electrodes and press start buttons with thumbs.
 - If the measurement fails three times in a row, the message appears as below. "The measurement can not complete due to the continuous errors. Step down from the scale for the initialization.
 - Refer to ERROR & REPAIR part for the detail.

⑧ Result screen

- After analysis is completed, the result is displayed on the screen.
- The result is presented with graph and numerical value so it is understood easily.
- Check the graph and numerical value of analysis result and press PRINT or NEXT button.



⑨ Printing the results and Restarting

- Once the result is displayed on the display, it can be printed out in pre-printed result sheet.
- After confirming the analyzed result, press NEXT button to restart.
- The device returns to the initial screen after one minute.

Note



1. When this device is connected to the A4 printer, pre-printed result sheet can be printed out.
2. If Automatic printing is selected at SYSTEM SETUP, the result sheet is automatically printed after the measurement. If 'PRINT' button is pressed, the same result sheet can be printed more.
3. When the program is installed in a computer connected to the device, the result can be viewed at PC, and it can be printed in preprinted result sheet. Refer to the program CD for the detail.

2) Analysis Using Blood Pressure Monitor/Software Program

The blood pressure monitor from SELVAS Healthcare, Inc. can be connected to the device as an option.



In this way, the blood pressure can be monitored together with weight control. It helps to manage the body fat while checking the blood pressure simultaneously. The measuring procedure is as follows.

- ① Connect a Blood Pressure Monitor to the device.
- ② Connect the device to a computer in which Body Pass Plus or Easy Body Plus is installed.
- ③ Turn on the power of BPM and the computer. Turn on the device.
- ④ Input personal data to create a new ID or input ID which already registered.
- ⑤ Measure blood pressure first.
- ⑥ Measure body composition.
- ⑦ The results of blood pressure and body composition are immediately displayed on the computer screen after the completion of body composition analysis.
- ⑧ Save the data or print it out.

Note



1. Blood pressure should be measured before body composition analysis. Refer to the user manual of blood pressure monitor for more detail.
2. The result of blood pressure can be printed on the result sheet or reviewed at the program.

STORAGE OF DATA USING USB MEMORY

1. Storage of data

1) Select of FLASH MEMORY

① Insert USB memory stick into USB(A) jack placed on the back side of the device.

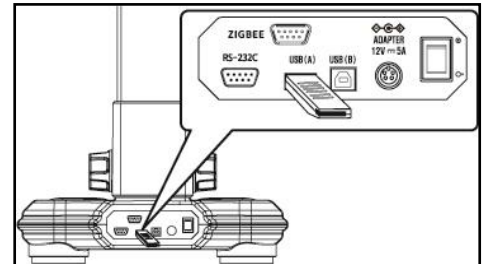

② The following message appears.

'Do you want to write data to USB memory stick?' on initial screen. Press 'YES' to send to USB memory.

③ Transmitting message will be displayed on the screen. When transmission is completed, the message 'The data writing was completed' will be shown. Press CLOSE to complete the saving process.



2) Select of USB MEMORY

When select 'USB MEMORY', measurement data will be stored at USB MEMORY without notification.

Data can be saved when USB MEMORY is inserted only at the initial screen of device only.

If USB MEMORY is not inserted during the measurement, the message "USB MEMORY is not connected" appears. Data will not be stored.

Please insert USB MEMORY and measure again.

If the message above appears even USB memory stick is inserted, take out the USB MEMORY and insert it again. Please use the USB MEMORY which provided by SELVAS Healthcare, Inc.

Note



The data can be saved only when 'ID USAGE' function is activated in SYSTEM SETUP.

Note



1. USB memory should be inserted only at the initial screen.
2. When there's no data saved in FLASH MEMORY, the message "No saved data." will appear. Please insert USB memory after measuring body composition.
3. When the saving format is changed from USB MEMORY to FLASH MEMORY, the data saved in USB MEMORY should be transferred to PC.
4. Please refer to Body Pass Plus program manual for more information.

2. ID Search (Only with FLASH MEMORY)

When press 'ID' button on the initial screen, ID search window will appear.

Enter the ID and press 'BACK' button.

The latest result will be displayed on the screen.

Press 'PRINT' to print out the result or press 'RESTART' to return to initial screen.

3. Data Deletion (Only with FLASH MEMORY)

Press '◀→1111→▶' on keypad in initial screen.

The following message appears. "Do you want to delete all data?"

If you want to delete the data, press YES to delete, otherwise press NO.

When deleting the data, the message 'All data were deleted' will appear. Press 'Close' to return to initial screen. (Deleted data can not be restored)

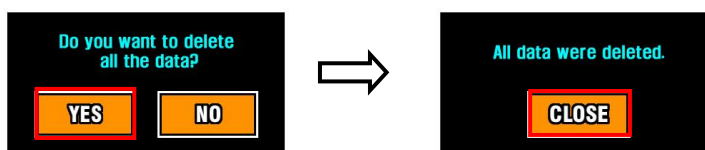

4. Data Backup (Only with FLASH MEMORY)

When error occurred while using FLASH MEMORY, error message appears as shown in the picture.

In this case, please turn off and on the power and insert USB on initial screen. Press '◀→7777→▶' in keypad.

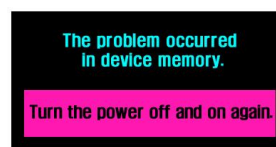

Note



There's a basic backup memory in FLASH MEMORY. However, when the data is damaged due to the hardware problem, restoring data may not be possible.

RESULT INTERPRETATION

Here's the explanation and the criteria of the printed results.

1. Personal Data

The subject's name / ID, date, height, weight, age and gender are indicated on the result sheet.

2. Logo

The user can input LOGO such as name of hospital, sports center, or obesity clinic, telephone number, address, contact person, etc.

Refer to the manual of Body Pass Plus or Easy Body Plus for logo insertion.

3. Body Composition Analysis

The body composition analysis is indicated in the ratio based on the subject's weight.

- ① Weight: It is the sum of total body water, mineral, protein, and body fat in the table.
- ② M.B.F. (Mass of Body Fat): It is calculated by subtracting lean body mass from weight.
- ③ L.B.M. (Lean Body Mass): It is calculated by subtracting mass of body fat from body weight.
Lean body mass consists of fat free mass of body such as muscle, organs, blood and water.
- ④ S.L.M.: (Soft Lean Mass): It composes of body water and protein.
- ⑤ Mineral: It composes of bone and electrolyte.
- ⑥ Protein: this is a major element that composes soft lean mass together with body water.
- ⑦ T.B.W. (Total Body Water): It consists of intra-cellular and extra-cellular water. For healthy adults, body water is 45 ~ 65% of body weight even though it varies between persons.
Assessment of Under, Optimal, and Over in the table is assessed by the optimal range based on standard weight of the subject.

4. Obesity Assessment

This assessment help to control the subject's body composition and weight. Body composition analysis result is compared with ideal body composition reflecting age and gender of the subject. The result is displayed in a bar graph. Optimal range of weight and soft lean mass is calculated on the basis of standard weight.

1) Percent Body Fat (P.B.F., %): It is the ratio (%) of the body fat based on the subject's weight.

	low-fat	normal	over-fat	obese	severe obese
Men	less than 15	15 ~ ≤ 20	20 ~ ≤ 25	25 ~ ≤ 30	over 30
Women	less than 20	20 ~ ≤ 30	30 ~ ≤ 35	35 ~ ≤ 40	over 40

2) Body Mass Index (B.M.I., Quetlet's Index: kg/m²): for adults

*EAST ASIA

thin	normal	overweight	obese
< 18.5	18.5 ~ ≤ 23	23 ~ ≤ 25	over 25

* EU and etc.

thin	normal	overweight	obese
< 18.5	18.5 ~ ≤ 25	25 ~ ≤ 30	over 30

5. Abdominal Analysis

Abdominal fatness is divided into subcutaneous type and visceral type. When it comes to body fat, experts say that it is important not only the amount of fat but also the distribution of it. If visceral fat area is over 100 cm², it is classified as "visceral obesity" regardless of P.B.F., W.H.R. or Body weight.

Waist-to-hip ratio (W.H.R.) shows the distribution of fat stored in one's abdomen and hip. It is simple but useful to assess fat distribution. Body fat is stored in two distinct ways. They are often called 'apple' and 'pear' type. Apple type shows bigger girth of waist than hip and pear type has bigger girth of hip than waist. If body fat in abdomen increases more, the risk to cardiovascular diseases, diabetes, etc. becomes higher.

1) W.H.R. (Waist to Hip Ratio)

W.H.R. is calculated by dividing waist girth by hip girth. When W.H.R. is below 0.9 (male) / 0.85 (female), the risk of visceral obesity is low.

2) Visceral Fat Level: The degree of visceral obesity is displayed in a level.

- Level 1~ 4 corresponds to subcutaneous fat type
- Level 5~ 8 corresponds to balanced type that subcutaneous and visceral fat is balanced.
- Level 9~10 corresponds to borderline type.
If subjects maintain current lifestyle, they will proceed to visceral fat type.
- Level 11~15 corresponds to visceral fat type I .
- Level 16~20 corresponds to visceral fat type II .

3) V.F.A. (Visceral Fat Area): optimal range is 50 ~ 100 cm² (male), 40 ~ 80 cm² (female).

4) Abdominal circumference: Optimal range is <102cm (male), <88cm (female).

Abdominal Circumference is an estimated value in case of measure the navel circumference.

6. Energy Expenditure

1) B.M.R. (Basal Metabolic Rate)

B.M.R. is the calories to maintain human body's basic function such as movement of heart, brain, neural transmission, regulating body temperature and so on. B.M.R. is in proportion to S.L.M. because body fat stores energy while muscle consumes energy. Therefore, even if the weight is same between persons, the person with more muscle has greater B.M.R.

2) T.E.E. (Total Energy Expenditure)

It is the sum of basal metabolic rate and calories needed for daily activity. Generally it is calculated by multiplying B.M.R. by PAL (Physical Activity Level).

7. A.M.B. (Age Matched of Body)

It is the estimated physical age of the subject considering body composition analysis result, gender, and biological age. This is calculated by comparing the optimal body composition based on the gender and biological age of the subject with the actual analyzed body composition. It can be used to evaluate the subject's health and body development.

8. Impedance

It is the resistance of human body to the electric current that flows through the body. Impedance value can be used in monitoring the function of this device and checking body change of the subject.

9. Body Type

Body type is determined by B.M.I and P.B.F. Body type is classified into 9 types; Low fat Low weight, Low fat Muscular, Athletic, Low weight, Standard, Over Weight Muscular, Thin fat, Over fat, Obese.

10. Segmental Assessment

Soft lean mass and body fat of five body parts (left and right arms, left and right legs, and trunk) are indicated in a diagram

11. Control guide

Control guide shows goal to control weight, mass of body fat, and soft lean mass based on body composition analysis result. The amount of calorie intake and exercise are recommended based on the current body status. Controlling 0.5kg per week is the most reasonable weight control method.

Control guide and calorie prescription are proposed value for one's body type.

12. Body composition change

Check to change of weight, body fat, and muscle from previous and present measurement

13. Blood Pressure

When the blood pressure monitor supplied from SELVAS Healthcare, Inc. is connected to the device, blood pressure can be measured and the result can be printed out. Systolic blood pressure, diastolic blood pressure, and pulse are printed on result sheet. It helps to recognize hypertension assessment related to obesity.

STORAGE & MAINTENANCE

- 1) Pay attention to the allowable value to electric current.
- 2) Avoid direct sunlight, humidity, dust, thick oil and salty or extreme changes in temperature.
 - ⊗ 3) Do not install or store the device in a place where any chemicals or gas is stored.
 - ⊗ 4) Do not use the device in any unstable, vibrating, or impact-giving area.
- 5) Connect the earth placed on the backside of this device to terminal plate to prevent any electric shock from leakage current or a potential difference.
 - ⊗ 6) Do not put or drop anything on the device and avoid strong impact.
 - ⊗ 7) Do not disassemble or remodel the device.
- 8) If this unit has not been used for a long time, use this after confirming by an expert if all function and appearance are in good condition.
 - ⊗ 9) Do not splash any fluid on this device or insert any foreign substances.
- 10) In case of inserting foreign substances or exposing to particular environment, this device must be examined by an expert before use.
- 11) Use the power cable, plug, and fuse that are offered by our company.

At this time, confirm the covering of cable, the state of plug connection, and other check points to the things below.

 - RS 232C cable
 - USB port
 - Adapter
- 12) When pulling out the power cable, turn off the power switch first and then pull the plug out.
- 13) Storage ambient: Temperature -25 ~ 70 °C, Humidity lower than 93 % (non condensing)
- 14) Operation ambient: Temperature 5 ~ 40 °C, Humidity 15 ~ 93 % (non condensing)
 - ⊗ 15) Do not store or use this device under 70 kPa (700 mbar) or over 106 kPa (1060 mbar) of atmospheric pressure.
- 16) Cleaning & Disinfection
 - ① Cleaning: Use a soft gauze cloth with volatile liquid like benzene and alcohol to clean it. Clean it every 2~3days. Do not use a wet cloth.
 - ② Disinfection: After measuerment, use a soft gauze cloth with volatile liquid like benzene and alcohol. Then, wipe the enclosure with a soft lint. Please wipe after every measurement for electrode disinfection.
- 17) Refer to "SAFETY PRECAUTIONS."

Caution



Users must wipe with safety equipments such as gloves in disinfecting electrode.

Our company does not take a responsibility for safety accident caused by user's carelessness.

ERROR & REPAIR

1. Kinds of Error & Repair

Error	Cause	Repair
Out of range of impedance	<p>When the subject's body impedance is deviated from the limit</p> <ul style="list-style-type: none"> - Insufficient touch to electrodes - Impedance is out of range - Range: 100 ~ 950 Ω 	<ul style="list-style-type: none"> • Clean the measuring parts (the electrodes, palms, and soles) and try again. • Measure again with correct posture. • Do not move during measurement. • If the same error is repeated, please contact our company or its local distributor where this device is purchased.
Out of range of body fat	<p>When the subject's P.B.F. is deviated from the limit</p> <ul style="list-style-type: none"> - Incorrect input of personal data - P.B.F. is out of range 	<ul style="list-style-type: none"> • Clean the Handle electrodes and try again. • If the same error is repeated, please contact our company or its local distributor where this device is purchased.
Out of range of measurement	<p>When the subject's fatness is deviated from the limit</p> <ul style="list-style-type: none"> - Mechanical error 	<ul style="list-style-type: none"> • Input height correctly. • Check the weight is correct and try again.. • If the same error is repeated, please contact our company or its local distributor where this device is purchased.
Can't input the height	<p>When the subject's height is deviated from the limit</p> <ul style="list-style-type: none"> - Incorrect input of height 	<ul style="list-style-type: none"> • Input height correctly. If the subject's height is out of the range, height can't be entered.
Can't measure the weight	<p>When the subject's weight is deviated from the limit</p> <ul style="list-style-type: none"> - Measuring error - Moving during the measurement 	<ul style="list-style-type: none"> • Measure weight again. If the subject's weight is out of range, weight can't be measured.

2. Error & Repair

Error	Cause	Repair
P.B.F. is measured too low or too high	<ul style="list-style-type: none"> - Measure in unstable condition such as right after the exercise, bath, sweat, or drinking lots of water. - Moving or speaking during the measurement - Handle electrodes or measuring parts are dirty. 	<ul style="list-style-type: none"> • Measure again in a stable condition with the correct posture. • Do not move or speak during the measurement. • Clean handle electrodes with soft gauze and try again. • Clean hands and soles and try again. • Make sure there are no foreign substances between electrodes and measuring body parts.
It does not work even when start buttons are correctly pressed.	<ul style="list-style-type: none"> - Defective cable between the head and the scale - Start buttons are defective. 	<ul style="list-style-type: none"> • Contact our company or its local distributor where this device is purchased.
	<ul style="list-style-type: none"> - Bad connection between the head and the scale - Handle electrodes are defective. 	<ul style="list-style-type: none"> • Check whether the handle electrodes are connected tightly to the head. • If the same error is repeated, please contact our company or its local distributor where this device is purchased.

AFTER SERVICE

1. AFTER SERVICE

! If there is any problem with the unit, please follow the steps below;

※ Contact our company's Overseas Service Department immediately.

After gathering the model name, Serial Number, date of purchase and description of the problem, contact our company with information shown below.

※ Try to solve the problem over the phone with the personnel of local service department.

If the problem cannot be solved over the phone, just return to service department directly.

※ Our company or local distributor will make available on-request circuit diagrams, component part list, descriptions, calibration or other information which will assist your appropriately qualified technical personnel to repair those parts of unit which are designated by our company as repairable.

How to contact our company

Write us at:

SELVAS Healthcare, Inc.

155, shinseong-ro, Yuseong-gu, Daejeon, 34109 Republic of Korea

TEL: 82-42-879-3000

FAX: 82-42-864-4462

(You can also contact the following representative or your local distributor)

2. PACKING AND TRANSPORT

Our company wraps this device up with the most suitable method to protect it from any impact or damage during shipping and transporting. This device can be damaged during delivery if it is packed with other ways except the one our company uses. Please handle this device carefully without any impact in packing and delivering it.

If this device needs to be transported wrap this device up again and transport it as follows.

- ① Turn off the power.
- ② Turn off the power of the peripheral devices and disconnect all cables.
- ③ Disassemble the device in reverse order of assembly.
- ④ Pack the device with the original packing materials.
- ⑤ Transport it carefully.

SPECIFICATION

Model	ACCUNIQ BC300
Measuring method	BIA via tetra-polar electrode method using 8 touch electrodes.
Frequency Range	5, 50, 250 kHz
Measuring site	Whole body and Segmental measurement (arms, legs, and trunk)
Main items	<p>[Result for Body Composition Analysis] Body Composition Analysis (Weight, LBM, Body fat, SLM, Protein, Mineral, TBW), Muscle/Fat analysis (Weight, SMM, Fat mass), Obesity analysis (BMI and assessment, PBF and assessment, Obesity degree), Abdominal analysis (WHR, VFL, VFA, AC), Segmental(Left arm, Right arm, Left leg, Right leg, Trunk) Fat mass/Lean mass, Body composition change (Previous, Present), Comprehensive evaluation (Body type, Biological age, BMR, TEE, BCM), Control guide (Target weight, Weight control, Muscle control, Fat control), Impedance (Segmental&Frequency), Blood pressure (when connected with blood pressure monitor of our company), QR code</p> <p>[Result for Child and Youth (optional)] Body Composition Analysis (Weight, LBM, Body fat, SLM, Protein, Mineral, TBW), Muscle/Fat analysis (Weight, SMM, Fat mass), Obesity analysis (BMI, PBF, WHR), Child growth curve (height, weight), Comprehensive evaluation (Body type, BMR, TEE, BCM, Obesity degree), Balance assessment (Upper body L/R, Lower body L/R), Control guide (Target weight, Weight control, Muscle control, Fat control), Segmental(Left arm, Right arm, Left leg, Right leg, Trunk) Fat mass/Lean mass, Impedance (Segmental&Frequency), QR code</p>
Current	Less than 280 μ A
Power supply	Input-AC 100~240V~, 50-60Hz, 1.5A Output-DC 12V, 5A, 60VA ADAPTER
Display	7 inch wide color LCD (640 x 480 pixel)
Input device	Key pad, PC remote control

Transmitting device	USB port
Printing device	USB port (the printer assigned by our company), thermal printer (option)
Dimension	400 × 735 × 890 mm (W × D × H, ± 20 mm)
Weight	About 10kg (main unit)
Measuring range	100 ~ 950 Ω
Measuring time	Within 1 minute
Input height	50 ~ 220 cm
Measuring weight	10 ~ 200 kg
Applicable age	1 ~ 99 years old
Operation ambient	Ambient temperature range +5 to +40 °C Relative humidity range 15 to 93 % (non condensing)
Storage ambient	Ambient temperature range -25 to +70 °C Relative humidity range lower than 93 % RH

※ For purpose of improvement, specifications and design are subject to change without notice.

WARRANTY

Warranty

Name of product	Body Composition Analyzer		
Name of model	ACCUNIQ BC300		
Serial number			
Period of warranty	Within 2 years from the date of manufacture		
Date of purchase			
Customer	Add.	Name Tel.	
Dealer (market)	Add.	Name Tel.	

Note



- When you receive this warranty, make sure that the name of the dealer and the month, day and year of purchase are all completed.
- This warranty will not be reissued, please keep it in a safe place.

Periodic Check List

Management No. _____

Item		Inspection Subject	Requirements	Judgment	Remarks
Visual Check					
Mainframe	1	Enclosure	No scratch, crack, deformation and rust	Pass/Fail	
	2	Labels and panels	No peeling and dust	Pass/Fail	
	3	LCD	No damage	Pass/Fail	
	4	Electrode	No scratch and damage	Pass/Fail	
Accessories	1	Power cord	No scratch and damage	Pass/Fail	
	2	User manual	Kept in proper place	Pass/Fail	
Mechanical Check					
Mainframe	1	Keys	Smooth operation	Pass/Fail	
	2	Recorder	Smooth operation with no abnormal sound	Pass/Fail	
Accessories	1	Power cord	Smooth operation and removal	Pass/Fail	
Electrical Check					
Performance	1	Power supply	Screen display upon power-on	Pass/Fail	
	2	Display	No abnormality and flickering	Pass/Fail	
	3	Printing	printing possible	Pass/Fail	
	4	Measurement	Proper measurement	Pass/Fail	
General Judgment				Pass/Fail	
Model		ACCUNIQ BC300		Serial No.	
Installation place				Date of purchase	
Check date		Checked by		Approved by	

Copy this sheet for use

If repair is required, write down so in the Remarks column.

Daily Check List

Management No. _____

Item		Inspection Subject	Requirements	Judgment	Remarks
Visual Check					
Mainframe	1	Enclosure	No scratch, crack, deformation and rust	Pass/Fail	
	2	Labels and panels	No peeling and dust	Pass/Fail	
	3	LCD	No damage	Pass/Fail	
	4	Electrode	No scratch and damage	Pass/Fail	
Accessories	1	Power cord	No scratch and damage	Pass/Fail	
	2	User manual	Kept in proper place	Pass/Fail	
Mechanical Check					
Mainframe	1	Key pad	Smooth operation	Pass/Fail	
	2	Recorder	Smooth operation with no abnormal sound	Pass/Fail	
Accessories	1	Power cord	Smooth operation and removal	Pass/Fail	
Electrical Check					
Performance	1	Power supply	Screen display upon power-on	Pass/Fail	
	2	Display	No abnormality and flickering	Pass/Fail	
	3	Printing	Waveform printing possible	Pass/Fail	
	4	Measurement	Proper measurement	Pass/Fail	
Other	1	Clock	Present date/time	Pass/Fail	
General Judgment				Pass/Fail	
Model		ACCUNIQ BC300		Serial No.	
Installation place			Date of purchase		
Check date		Checked by	Approved by		

Copy this sheet for use

If repair is required, write down so in the Remarks column.