

User Manual

[www.accuniq.com](http://www.accuniq.com)



# User Manual BP210



**selvas**<sup>HE</sup>  
Healthcare



The device bears the CE label in accordance with the provisions of Medical Device Directive 93/42/EEC.

THE PERSONS RESPONSIBLE FOR PLACING DEVICES ON THE EC MARKET UNDER MDD 93/42/EEC



SELVAS Healthcare, Inc.

155, Shinseong-ro, Yuseong-gu, Daejeon, 34109 Republic of Korea

TEL: 82-42-879-3000, FAX: 82-42-864-4462



VITAKO Sp. z o.o.

ul. Stanisława Żaryna 7c 02-593 Warszawa, POLAND

TEL: +48 505 522 888

# TABLE OF CONTENTS

• <b>INTRODUCTION</b> .....	4
1. INTENDED USE.....	4
2. WORD DEFINITIONS.....	4
3. CLASSIFICATION AND COMPLIANCE.....	5
4. SAFETY PRECAUTIONS.....	5
5. SAFETY SYMBOLS AND INFORMATION.....	8
6. Guidance for Electromagnetic compatibility (EMC) .....	10
• <b>TERMS OF EACH PART AND FUNCTIONS</b> .....	15
1. FRONT PART.....	15
2. PRINTER.....	17
3. REAR PART.....	18
4. ACCESSORIES.....	20
5. OPTIONS.....	20
• <b>INSTALLATION</b> .....	21
1. CONNECTING ADAPTER.....	21
2. LOADING THE PRINT PAPER.....	21
3. CONNECTING PORTS (RS-232C).....	22
4. SETTING TIME AND DATE.....	23
• <b>MEASUREMENT</b> .....	25
1. CAUTIONS FOR MEASUREMENT.....	25
2. MEASUREMENT.....	26
3. DATA ON MEASUREMENT BY PRINTER.....	29
• <b>OPTION</b> .....	31
• <b>MAINTENANCE</b> .....	39
• <b>ERROR&amp;REPAIR</b> .....	41
• <b>AFTER SERVICE</b> .....	42
1. AFTER SERVICE.....	42
2. PACKING AND TRANSPORT.....	42
• <b>SPECIFICATION</b> .....	43
• <b>WARRANTY</b> .....	44

## INTRODUCTION

We highly appreciate that you chose our company's product.

You are kindly requested to be familiar with these directions before using this product and always keep it together with the product. In case you are not sure about any directions or problems arising while using the product, please contact our service center.

We will provide you with detailed instructions.

### 1. INTENDED USE

ACCUNIQ BP210 Automatic Blood Pressure Monitor is designed to measure systolic and diastolic blood pressure and pulse rate of Persons who are 18 years and older using the oscillometric method on a cuffed arm.

ACCUNIQ BP210 (Left type) measure the Left arm.

ACCUNIQ BP210 (Right type) measure the Right arm.

- Target user: Persons who are 18 years and older
- This medical device is not for home use

### 2. WORD DEFINITIONS

To ensure safe operation and long term performance stability, it is essential that you fully understand the functions, operating and maintenance instructions by reading this manual before operating your unit.

Particular attention must be paid to all warnings, cautions and notes incorporated herein.

The following conventions are used throughout the manual to denote information of special emphasis.

#### Warning



Important information to indicate any possible hazard which can cause severe personal injury or death from substantial property damage when ignored.

#### Caution



Important information to indicate any possible hazard which will or can cause minor personal injury or property damage when ignored.

#### Note



Important information to notify to the user about installation, operation, or maintenance information which is important but not hazardous. Warnings against hazard are not to be included under the NOTE signal word.

### 3. CLASSIFICATION AND COMPLIANCE

1) This device is classified as;

- Class 1 type-BF against electric shock
- Ordinary equipment without protection against ingress of water
- Equipment not suitable for use in presence of a flammable anesthetic mixture by standard of EN 60601-1: 2006(Basic safety and essential performance of Medical Electrical Equipment)







2) This device is complied with Class A for Noise-Emission, Level B for Noise-immunity, by standard of IEC 60601-1-2:2007(Electromagnetic Compatibility Requirements).

3) This device is complies with the EN 1060-1: 1995+A2:2009 Non-invasive Sphygmomanometers general requirements as well as EN 1060-3: 1997+A2:2009 supplementary requirements for electro-mechanical blood pressure measuring systems.

### 4. SAFETY PRECAUTIONS

This device is designed and manufactured with consideration of safety of the operator and subject and also to the reliability of the unit.

The following precautions must be observed for additional safety;

-  1) The unit must be operated only by, or under supervision of a qualified person with our company or our distributors.
- 2) This device is specified as Class 1 type BF unit under the standard of IEC 60601-1:2005(Safety of Medical Electrical Equipment).
-  Do not touch or handle inner side of the system at any time.
-  The INTERNAL ELECTRICAL POWER SOURCE is to be used if the integrity of the PROTECTIVE EARTH CONDUCTOR or the protective earthing system in the installation is in doubt.
-  3) Do not modify the unit. If any modification is needed, ask our company or its authorized dealer for service.
- 4) The unit has previously been adjusted in the factory for optimum performance.
-  Do not attempt to adjust switches or any other things except those specified in this manual for operation.
-  5) If you have experienced any trouble with the unit, switch it off immediately, and contact our company or its authorized dealer for assistance.
- 6) If you plan to connect any device of other manufacturers electrically or mechanically to the unit, contact our company or its authorized dealer for instructions before doing so.

When you connect computer or other system to the unit (RS-232C), the attached systems should be those certified by IEC 60950 or equivalent standards for data processing equipment.

Configurations shall comply with the system standard IEC 60601-1:2005.

Everybody who connects additional equipment to the signal input part or signal output part configures a medical system standard IEC 60601-1:2005.

If in doubt, consult the A/S department of local distributor.

- ⚠ 7) Avoid the following environments for storage;
- Where the ambient temperature falls  $-20^{\circ}\text{C}$  or exceeds  $60^{\circ}\text{C}$ .
  - Where the atmospheric pressure falls below  $70\text{kPa}$  ( $700\text{mbar}$ ) or exceeds  $106\text{kPa}$  ( $1060\text{mbar}$ ).
  - Where the humidity is over 95% non-condensing.
  - Where the unit is exposed to spray or splashing water.
  - Where the unit is exposed to dust.
  - Where the unit is exposed to water vapor.
  - Where the unit is exposed to salty atmosphere.
  - Where the unit is exposed to explosive gas.
  - Where the unit is exposed to excessive shocks or vibrations.
  - Where the angle of inclination of mounting surface exceeds 10 degrees.
  - Where the unit is exposed to direct sunlight.
- ⚠ 8) This equipment has been tested and found to comply with the limits for medical devices to the IEC 60601-1-2:2007. These limits are designed to provide reasonable protection against harmful interference in a typical medical installation. This equipment generates uses and can radiate radio frequency energy and, if not installed and used in accordance with the instructions, may cause harmful interference to other devices in the vicinity. However, there is no guarantee that interference will not occur in a particular installation. If this equipment does cause harmful interference to other devices, which can be determined by turning the equipment off and on, the user is encouraged to try to correct the interference by one or more of the following measures:
- Reorient or relocate the receiving device.
  - Increase the separation between the equipment.
  - Connect the equipment into an outlet on a circuit different from that to which the other device(s) are connected.
  - Consult the manufacturer or field service technician for help.
- ⊘ 9) Do not to touch signal input, signal output or other connectors, and the patient simultaneously.
- ⚠ 10) a statement that MEDICAL ELECTRICAL EQUIPMENT needs special precautions regarding EMC and needs to be installed and put into service according to the EMC information provided in the ACCOMPANYING DOCUMENTS;
- ⚠ 11) a statement that portable and mobile RF communications equipment can affect MEDICAL ELECTRICAL EQUIPMENT.
- ⚠ 12) Please consult a physician or a trained health professional for interpretation of measurement results.
- ⚠ 13) No phthalates are used for this product and its container.
- ⚠ 14) The cuff is not made with natural rubber latex

**Caution**

1. Measurements may be impaired if this device is used near televisions, microwave ovens, X-ray equipment or other devices with strong electrical fields. To prevent such interference, use the meter at a sufficient distance from such devices or turn them off.
2. Incorrect operation or failure of user to maintain the unit spares the manufacturer or his agent of the responsibility for system's non-compliance with specifications or responsibility for any damage or injury.

**Caution**

This manual is made for informational purpose and this manual and product are not meant to be a substitute for the advice provided by your own physician or other medical problem. You should not use the information contained in the product for diagnosis or treatment of health problem or prescription of medication by yourself. If you have or suspect that you have a medical problem, consult with your physician promptly.









Defective unit or accessories must be packed in the replacement cartons to be shipped off from you to our company.

Shipping and insurance costs for return of defective unit must be prepaid by the users.



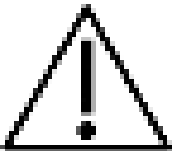





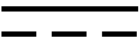

## 5. SAFETY SYMBOLS AND INFORMATION

The International Electrotechnical Commission (IEC) has established a set of symbols for medical electrical equipment which classifies a connection or warning of any potential hazard.

The classifications and symbols are shown below. Save these instructions for your safety.

	<p>Degree of protection against electric shock: TYPE BF</p>
	<p>Please observe operating instructions</p>
	<p>General warning sign</p>
	<p>General prohibition sign</p>
	<p>General mandatory action sign</p>
	<p>Caution</p>
	<p>Waste Electrical and Electronic Equipment (WEEE) The device could be sent back to the manufacturer for recycling or proper disposal after their useful lives. Alternatively the device shall be disposed in accordance with national laws after their useful lives.</p>
	<p>"OFF" (only for a part of equipment)</p>
	<p>"ON" (only for a part of equipment)</p>



	<p>This symbol is used inside system. Identifies the point where the safety ground of the system is fastened to the chassis.</p>
	<p>Do not open. This is for factory only.</p>
	<p>Alternating current</p>
	<p>Direct current</p>
	<p>Date of manufacture</p>
	<p>Manufacturer</p>
	<p>Non-ionizing radiation</p>
	<p>CE mark</p>
	<p>Serial No.</p>
	<p>Authorized representative in the European community.</p>
	<p>Keep dry</p>
	<p>RoHS2</p>

## 6. Guidance for Electromagnetic compatibility (EMC)

Details about the electromagnetic compatibility (EMC) of the ACCUNIQ BP210 are given below. Before using the ACCUNIQ BP210, be sure to read and understand the following information.

### 1) Guidance and manufacturer's declaration – electromagnetic emissions

The ACCUNIQ BP210 is intended for use in the electromagnetic environment specified below. The customer or the user of the ACCUNIQ BP210 should assure that it is used in such an environment.

Emissions test	Compliance	Electromagnetic environment – guidance
RF emissions CISPR 11	Group 1	The ACCUNIQ BP210 uses RF energy only for its internal function. Therefore, its RF emissions are very low and are not likely to cause any interference in nearby electronic equipment.
RF emissions CISPR 11	Class B	The ACCUNIQ BP210 is suitable for use in all establishments, including domestic establishments and those directly connected to the public low-voltage power supply network that supplies buildings used for domestic purposes.
Harmonic emissions IEC 61000-3-2	Class A	
Voltage fluctuations/ flicker emissions IEC 61000-3-3	Compliance	

### 2) Guidance and manufacturer's declaration – electromagnetic immunity

The ACCUNIQ BP210 is intended for use in the electromagnetic environment specified below. The customer or the user of the ACCUNIQ BP210 should assure that it is used in such an environment.

Immunity test	IEC 60601 test level	Compliance level	Electromagnetic environment-guidance
Electrostatic discharge(ESD) IEC 61000-4-2	±6kV: Contact ±8kV: Air	±6kV: Contact ±8kV: Air	Floors should be wood, concrete or ceramic tile. If floors are covered with synthetic material, the relative humidity should be at least 30 %.
Electrical fast transition/burst IEC 61000-4-4	±2kV: Power supply lines ±1kV:	±2kV: Power supply lines ±1kV:	Mains power quality should be that of a typical commercial or hospital environment.

	Input/output lines	Input/output lines	
Surge IEC 61000-4-5	±1 kV differential mode ±2 kV common mode	±1 kV differential mode ±2 kV common mode	Mains power quality should be that of a typical commercial or hospital environment.
Voltage drops, dips, and fluctuations of input power supply line IEC 61000-4-11	<5 % <i>UT</i> (>95 % dip in <i>UT</i> ) for 0,5 cycle 40 % <i>UT</i> (60 % dip in <i>UT</i> ) for 5 cycles 70 % <i>UT</i> (30 % dip in <i>UT</i> ) for 25 cycles <5 % <i>UT</i> (>95 % dip in <i>UT</i> ) for 5 sec	<5 % <i>UT</i> (>95 % dip in <i>UT</i> ) for 0,5 cycle 40 % <i>UT</i> (60 % dip in <i>UT</i> ) for 5 cycles 70 % <i>UT</i> (30 % dip in <i>UT</i> ) for 25 cycles <5 % <i>UT</i> (>95 % dip in <i>UT</i> ) for 5 sec	Mains power quality should be that of a typical commercial or hospital environment. If the user of the ACCUNIQ BP210 requires continued operation during power mains interruptions, it is recommended that the ACCUNIQ BP210 be powered from an uninterruptible power supply or a battery.
Magnetic field of commercial frequency (50/60Hz) IEC 61000-4-8	3 A/m	3 A/m	Power frequency magnetic fields should be at levels characteristic of a typical location in a typical commercial or hospital environment.

**Note**



*UT* is the a.c. mains voltage prior to application of the test level.

### 3) Guidance and manufacturer's declaration – electromagnetic immunity 2

The ACCUNIQ BP210 is intended for use in the electromagnetic environment specified below. The customer or the user of the ACCUNIQ BP210 should assure that it is used in such an environment.

Immunity test	IEC 60601 test level	Compliance level	Electromagnetic environment-guidance
Conducted RF IEC 61000-4-6	3 Vrms 150 kHz to 80 MHz	3 Vrms	<p>Portable and mobile RF communications equipment should be used no closer to any part of the ACCUNIQ BP210, including cables, than the recommended separation distance calculated from the equation applicable to the frequency of the transmitter.</p> <p><b>Recommended separation distance</b></p> $d = 1.2\sqrt{P}$ $d = 1.2\sqrt{P} \text{ 80 MHz to 900 MHz}$ $d = 2.3\sqrt{P} \text{ 900 MHz to 2,5 GHz}$
Radiated RF IEC 61000-4-3	3 V/m 80 MHz to 2,5 GHz	3 V/m	<p>where <math>P</math> is the maximum output power rating of the transmitter in watts (W) according to the transmitter manufacturer and <math>d</math> is the recommended separation distance in meters (m).</p> <p>Field strengths from fixed RF transmitters, as determined by an electromagnetic site survey,<sup>a</sup> should be less than the compliance level in each frequency range.<sup>b</sup></p> <p>Interference may occur in the vicinity of equipment marked with the following symbol:</p>

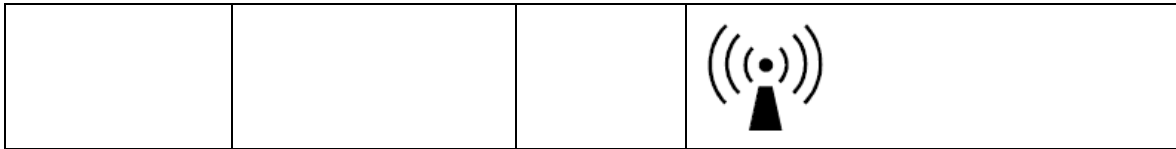

<b>Caution</b>	<p>1. At 80 MHz and 900 MHz, the higher frequency range applies.</p> <p>2 These guidelines may not apply in all situations. Electromagnetic propagation is affected by absorption and reflection from structures, objects and people.</p> <p><sup>a</sup> Field strengths from fixed transmitters, such as base stations for radio (cellular/cordless) telephones and land mobile radios, amateur radio, AM and FM radio broadcast and TV broadcast cannot be predicted theoretically with accuracy. To assess the electromagnetic environment due to fixed RF transmitters, an electromagnetic site survey should be considered. If the measured field strength in the location in which the ACCUNIQ BP210 is used exceeds the applicable RF compliance level above, the ACCUNIQ BP210 should be observed to verify normal operation. If abnormal performance is observed, additional measures may be necessary, such as reorienting or relocating the ACCUNIQ BP210.</p> <p><sup>b</sup> Over the frequency range 150 kHz to 80 MHz, field strengths should be less than 3 V/m.</p>

**4) Recommended separation distances between portable and mobile RF communications equipment and the ACCUNIQ BP210**

The ACCUNIQ BP210 is intended for use in an electromagnetic environment in which radiated RF disturbances are controlled. The customer or the user of the ACCUNIQ BP210 can help prevent electromagnetic interference by maintaining a minimum distance between portable and mobile RF communications equipment (transmitters) and the ACCUNIQ BP210 as recommended below, according to the maximum output power of the communications equipment.

Rated maximum output power of transmitter W	Separation distance according to frequency of transmitter m		
	150 kHz to 80 MHz $d=1.2\sqrt{P}$	80 MHz to 900 MHz $d=1.2\sqrt{P}$	900 MHz to 2,5 GHz $d=1.2\sqrt{P}$
0.01	0.12	0.12	0.23
0.1	0.38	0.38	0.73
1	1.2	1.2	2.3
10	3.8	3.8	7.3
100	12	12	23

For transmitters rated at a maximum output power not listed above, the recommended separation distance d in meters (m) can be estimated using the equation applicable to the

frequency of the transmitter, where P is the maximum output power rating of the transmitter in watts (W) according to the transmitter manufacturer.

## Caution



1. At 80 MHz and 900 MHz, the separation distance for the higher frequency range applies.
2. These guidelines may not apply in all situations. Electromagnetic propagation is affected by absorption and reflection from structures, objects and people.

## TERMS OF EACH PART AND FUNCTIONS

### 1. FRONT PART

#### ① START BUTTON

Press START button after being ready to measure, the cuff will be wrapped automatically and begins to pressurize.

#### ② STOP BUTTON

Press STOP button if you want to stop it during measurement. Pressurizing will stop and the air will exhaust from the cuff.

#### ③ SYSTOLIC DISPLAY

It indicates systolic blood pressure values.

#### ④ DIASTOLIC DISPLAY

It indicates diastolic blood pressure values.

#### ⑤ PULSE DISPLAY

It indicates pulse rate.

#### ⑥ TIMER

It indicates time.

#### ⑦ EMERGENCY STOP BUTTON

When your arm is oppressed due to high pressurizing or irregular operation is done, press this button then the cuff will be exhausted rapidly.

#### ⑧ PRINTER COVER

It protects the printer.

#### ⑨ AUTOMATIC CUTTER (printing paper let-out slot)

Printing paper is automatically cut off when it comes out through the slot.

#### ⑩ CUFF

It wraps and releases the arm automatically for measurement.

#### ⑪ ARM REST

When the arm is placed on the cuff, the arm supporter sustains the arm and makes the right position.

#### ⑫ HUMAN SENSOR(option)

When a user approaches, power is automatically turned on and vice versa.

#### ⑬ RFID CARD-READER(option)

When RFID card is applied, it reads information in it and stores the measured results.

#### ⑭ MAGNETIC CARD-READER(option)

When magnetic card is swiped, it reads information in it and stores the measured results.

## Note



The cuff and the buttons (START and STOP button) of this device are located at reverse side by R and L type.

## FRONT PART

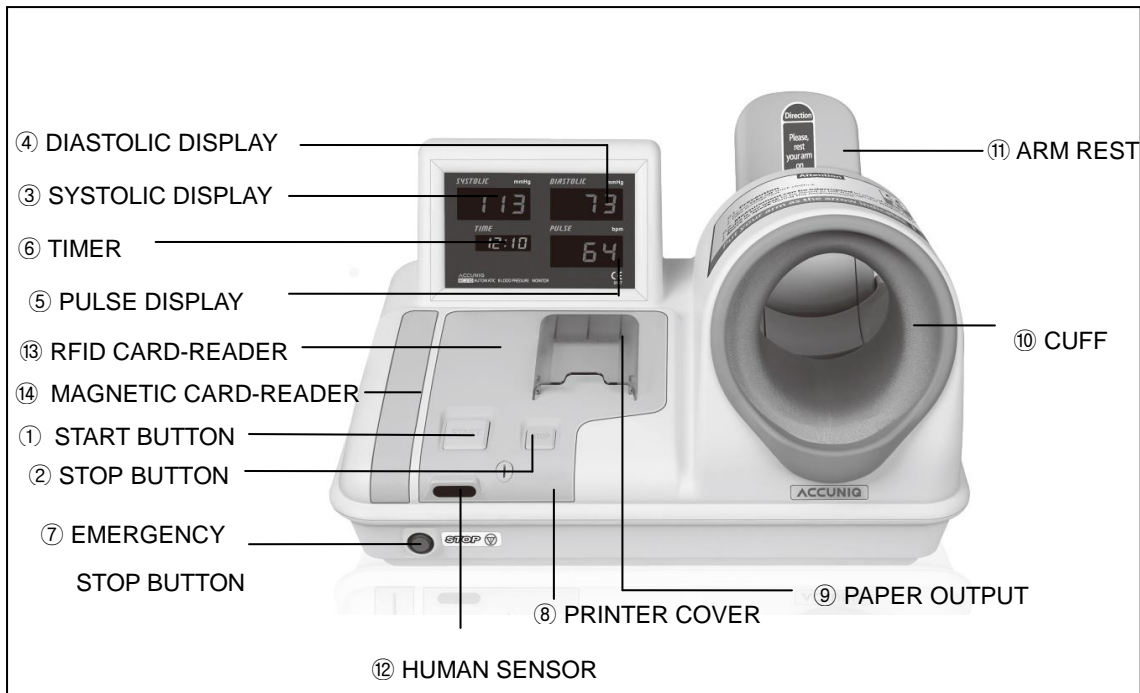

## Note



Printer, card reader and human sensor are optional.

ID card can be issued either by the machine manager or by the manufacturer of the model.

The card stores six previous measured results and can contain seven measured results with the current one altogether.

When the model manager writes the card, please refer to the manual and specifications for operation and programs attached to the card writing device at purchase.



## 2. PRINTER

### ① PRINT button

- Use it when you print out the data.
- If you set [ON] at the rear (PRINT ON/OFF switch), the data is printed automatically even when you do not press PRINT button.
- Normally, when you press this button, one previous data will be printed. (If you turn it off, all memorized data would be deleted.)
- When you set the date and time, the number goes up with this button pressed.

### ② FEED button

- Use this button for setting the paper.
- When you set the date and time, the number goes down with this button pressed.

### ③ SET button

- Set the date and time.
- The functions are as follows when pressing this before or after measurement.  
(It does not work during measurement)
- Sequence is HOUR → MIN. → MON. → DAY → YEAR
- If you do not press PRINT or FEED button within 5seconds, setting of the date and time finished.
- See the page '15' for detailed method.

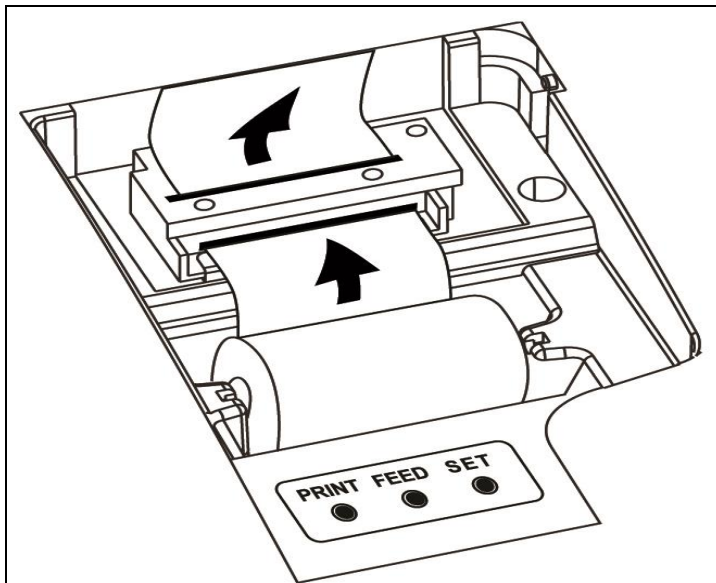

### 3. REAR PART

① POWER

It is used to turn the power on and off.

② POWER INPUT

It is used to connect with the adapter.

③ CAL

This is only for inspection. Never open it.

④ EARTH (POTENTIAL EQUALIZATION TERMINAL)

Please make sure for safety.

⑤ COMMUNICATION PORTS (RS-232C)

Connect between the main body and a computer or other equipment with cable (RS-232C) to transfer the data collected or measured. Or connect between the main body and the coin slot with RS-232C cable to transfer the data.

⑥ BACK MONITOR PORT(option)

Connect the main body to the reverse monitor cable.

⑦ USB PORT

Connect the main body and USB cable.

⑧ SENSOR ON/OFF

Human sensor is switched on and off.

⑨ SOUND ON/OFF

Music and voice output functions are activated with the switch [ON], and vice versa.

⑩ CARD ON/OFF

Card is usable when the switch [ON], and vice versa.

⑪ PRINT ON/OFF

Measured results are printed out when switched [ON], and vice versa.

⑫ VOLUME (ANNOUNCE ON/OFF)

It controls volume output when switch is on while all volume is [OFF].

⑬ REVERSE MONITOR(optional)

You can see the ID No, B.M.I., and Fatness as well as Blood Pressure on the reverse monitor.

⑭ INFORMATION BOARD FIXER

Fix the information board here.

## Note



1. While sound switch is activated on (so sound is functioning), place the VOLUME ON/OFF switch to [OFF] for deactivation of voice message and music play.
2. Printer, card reader, human sensor and reverse monitor is optional.
3. The operator should not touch both USB port and the patient's body simultaneously.

## Note



The operator shall not contact the parts (SIP/SOP) and the patient simultaneously and "SIP/SOP shall be available to operator only"

## REAR PART

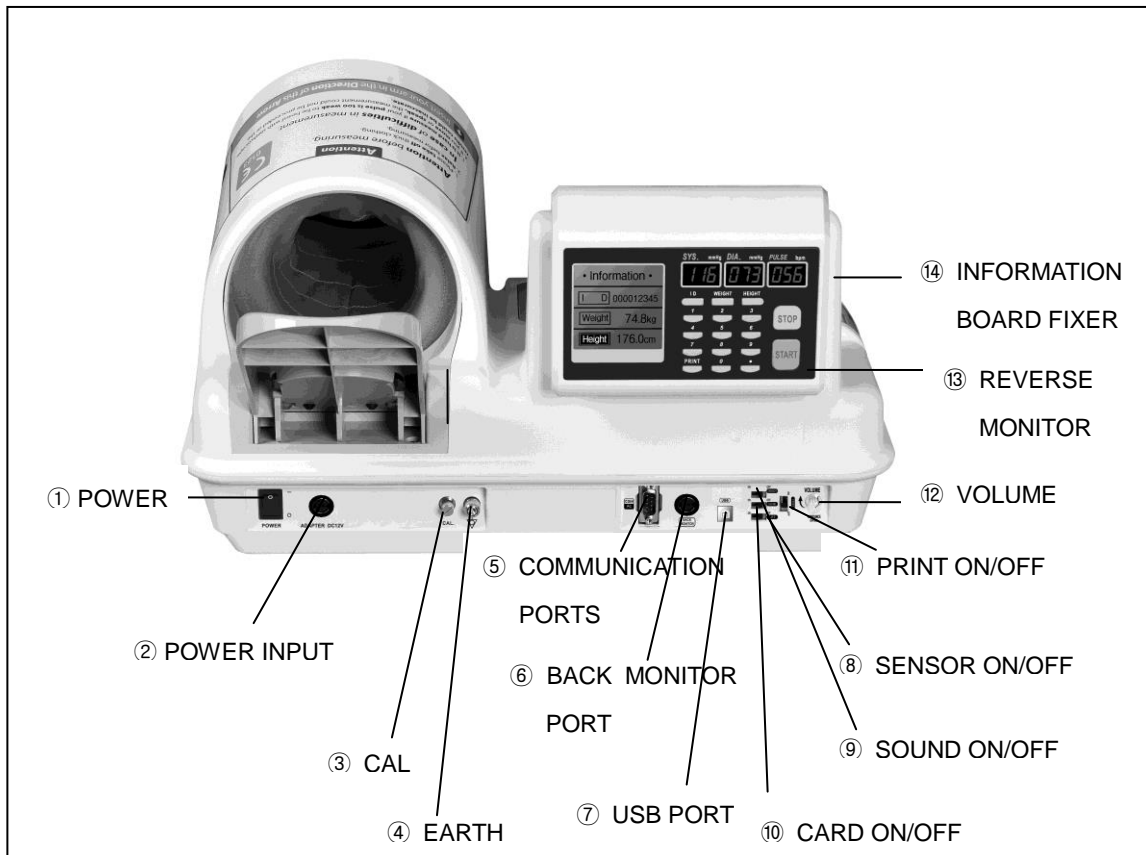

## 4. ACCESSORIES

Adapter/Power cable

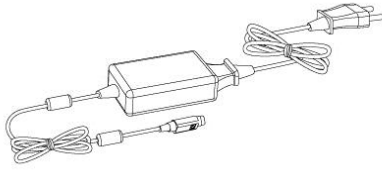

User guide



Guide



## 5. OPTIONS

Cart / Chair



RFID Card/Magnetic Card



Thermal paper / Printer



Human sensor



Reverse monitor

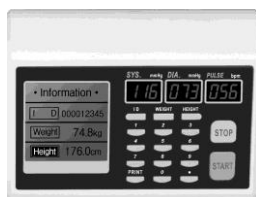

Reverse monitor support/cable

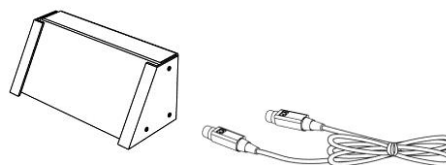

## INSTALLATION

### 1. CONNECTION ADAPTER

Just connect the power cable to the adapter on the rear and turn the POWER ON/OFF switch on the lower part of the rear (See the picture).

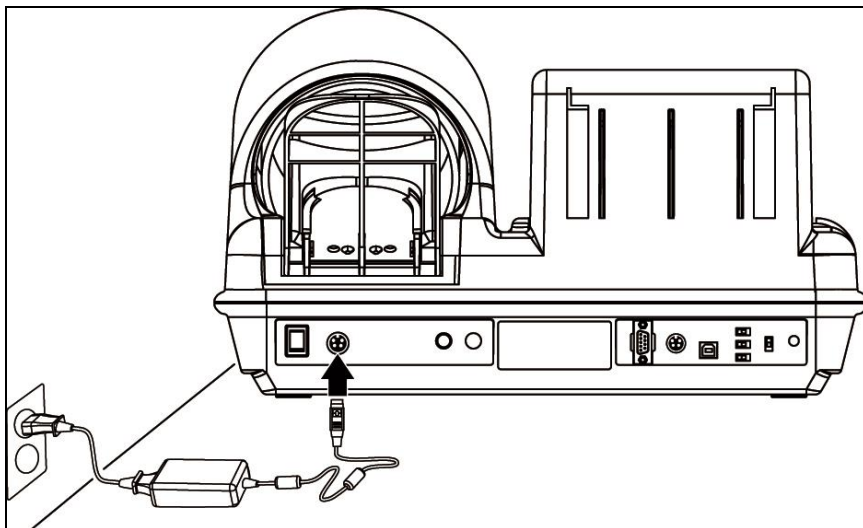

#### Caution



In order to avoid the risk of electrical shock, connect this device only to the power supply equipped with the protective grounding.

#### Caution



When connecting adaptor, place the arrow mark of adaptor connection part up and correctly stick it in the socket on the rear of the main body. Wrong connection could be a fire hazard.

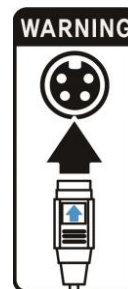

### 2. LOADING THE PRINT PAPER

- ① Check and see if power is turned on.
- ② Turn the nut (with a driver on the groove in the middle) on the lower printer cover clockwise to 90 degrees and open the cover.
- ③ Load the print paper as shown in the picture.
- ④ Insert the paper edge deep under the black roll, then it comes out above the CUTTER.
- ⑤ Balance the paper in the right place.
- ⑥ Cut the paper by pressing the FEED button.
- ⑦ Close the cover and turn the nut counterclockwise back.

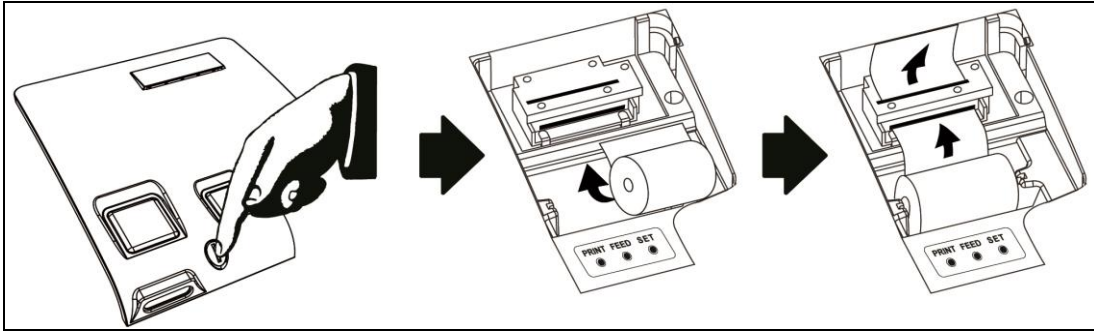

## Note



Being thermal type, printing is photocopied on one side of the paper (slippery side), without using printing ink.

Please check remainder of the paper always and then replace it.

Please use exclusive paper (58mm).

Keep paper rolls in a dark and ventilated place.

Avoid any dust on the paper.

Do not pull the paper during printing. It could cause jam.

When printing paper is not loaded in correct place, it may cause the malfunction of the printer or paper will be shoved out.

After the exchange of paper to the printer cover does not close properly, the alarm sounds, LED on the 'Err' is displayed. Please check the status of the printer cover.

### 3. CONNECTING PORT (RS-232C)

To transmit the data, connect a computer or other external options to the unit.

Connect the RS-232C cable both to port of the unit and to the computer jack or other external options.

(See the picture)

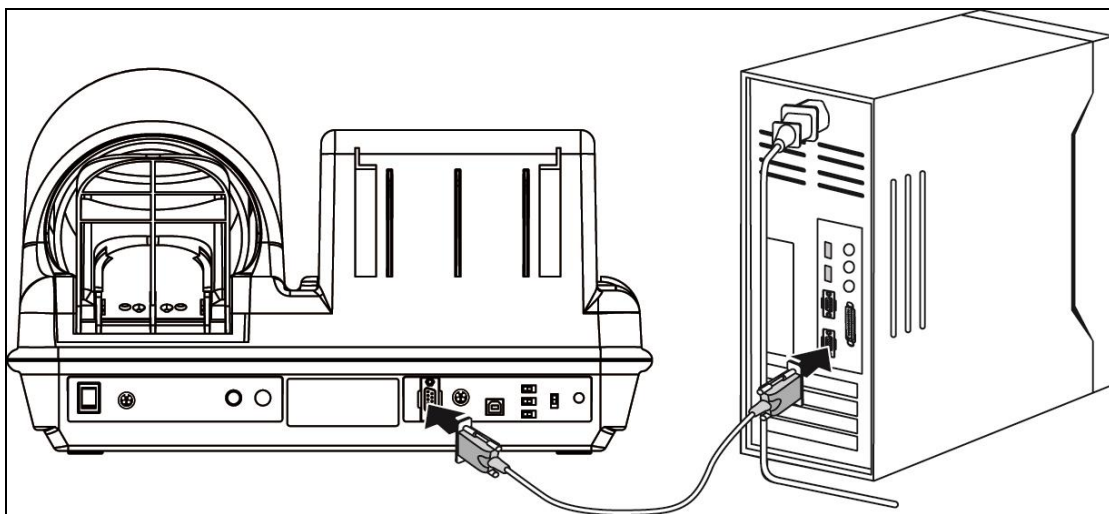

#### 4. SETTING TIME AND DATE

- Turn on the unit.
- Open the printer cover.
- Sequence is HOUR → MINUTE → MONTH → DAY → YEAR

##### HOUR

- ① Press SET button, then indicator will blink. At that time, press PRINT button. Its counts that have been measured since keeping button ON will be printed.
- ② Press SET button once again. First 2 figures will blink.
- ③ To set the current hour, press PRINT button to make the number goes up or press FEED button to make the number goes down.



##### MINUTE

- ① After setting the hour, press the SET button again.
- ② In this time, last 2 figures will blink.
- ③ As the same way as above, set the current minute with PRINT and FEED button.



##### MONTH

- ① After setting the minute, press SET button again.
- ② First 2 figures will blink.
- ③ Set the current month with PRINT and FEED button.



##### DAY

- ① After setting the month, press SET button again.
- ② Last 2 figures will blink.
- ③ Set the current day with PRINT and FEED button.



##### YEAR

- ① After setting the day, press SET button again.
- ② First 2 figures will blink.
- ③ Set the current year with PRINT and FEED button.



**Note**

If you want to measure blood pressure during setting the date and time, press STOP button. Then you can measure again immediately.

**Note**

You should set all data at once (hour, minute, month, day and year).

In case of stopping setting, the values return to previous ones which you have done before.

The calendar and time functions work without plugging power cord in.

Calendar program is inputted for 100 years, and it would be adjusted automatically even at a leap year.



# MEASUREMENT

## 1. CAUTIONS FOR MEASUREMENT

Take off heavy sweater or shirts.



Before measurement, take it easy and have a rest for a while.



Do not chat or move while you are being measured.



Do not measure in bad positions such as standing, half seat or sitting with your legs crossed.



When you fold your sleeves up, please make sure not to press your arm.



Put your arm deeply in order to fit to the arm rest.



If it is not easy to check your pulse with the stethoscope, the measurement cannot go on.



If you strain to your arm, there will be some differences. Please relax your arm and have a seat correctly.



## 2. MEASUREMENT

- ① Check the voltage and turn the power on.

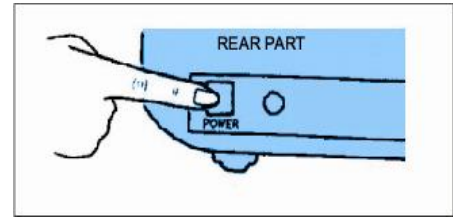

- ② With the switch-on, a music sound flows as the LED screen is activated.  
But, the SOUND ON/OFF switch in the rear of the unit should be set as 「ON」

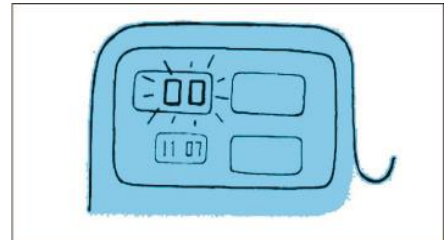

- ③ For the card users, proceed with checking after entering the card into the card-reader.  
When the card is inserted, a voice message comes out to “Press the start button.”

### Note



For ID card using, the CARD ON/OFF switch in the rear of the unit should be set as 「ON」 .

If the card is damaged or expired, the voice message comes out as “Can not use ID card.”

In this case, purchase new one and try again.

- ④ put either the right arm or left arm into the cuff.

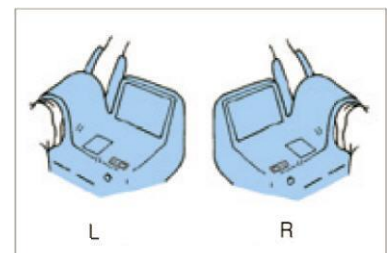

### Note



An optimal arm circumference for this equipment is 9” to 14”.

### Caution



Place your arm on the arm supporter with the palm facing up through the cuff deeply. Adjust the height of the chair so that the arm is leveled off with the heart. When the arm is placed lower than the heart, blood pressure will become higher than actual value, and vice versa.

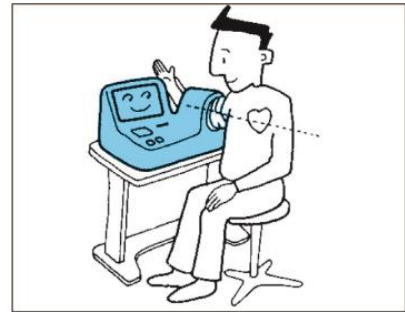

- ⑤ Press the START button and then the cuff is automatically inflated and the measurement is stated.

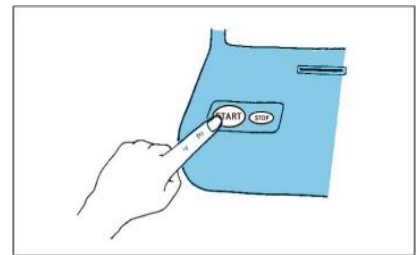

### Caution



When the measurement is started, the voice message is announced as “Starting measurement, don’t move or speak please.” When you feel painful and want to stop the measurement, press EMERGENCY BUTTON.



- ⑥ When the measurement completed, the cuff is automatically deflated and it returns to normal condition. Simultaneously, the voice message is announced as “Measurement completed, pull your arm out please. Thank you.”

### Note



When the measurement is not satisfactory, the voice message comes out as “Cannot measure, we will try again.” At this time, let your arm stay into the cuff and start over again from the beginning.

- ⑦ Blood pressure and pulse rate are displayed on LED and then the results are printed out. Also the results are informed by the voice message as “Your blood pressure is systolic 000, diastolic 000 and pulse 000.”



- ⑧ Pull your arm out from the cuff.

<b>Note</b>	When the PRINT ON/OFF switch on the rear is set as 「OFF」, the result will not be printed even if the measurement is completed.

<b>Note</b>	For the card users, six previous results stored in the card can be recalled to compare with the current ones newly checked. Seven results altogether could be printed out.

<b>Caution</b>	This device is only for adult.

### 3. DATA ON MEASUREMENT BY PRINTER

#### ▼ Results on Printing Paper

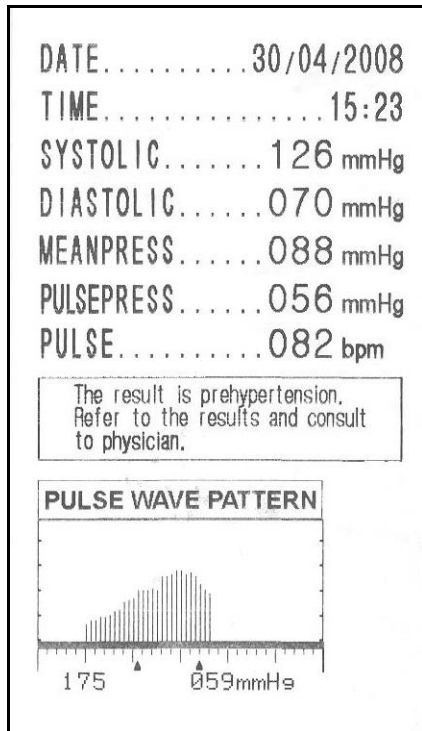

#### Classification of the blood pressure

: National High Blood Pressure Education Program, National Heart, Lung and Blood institute, NIH (JNC7, 2003)

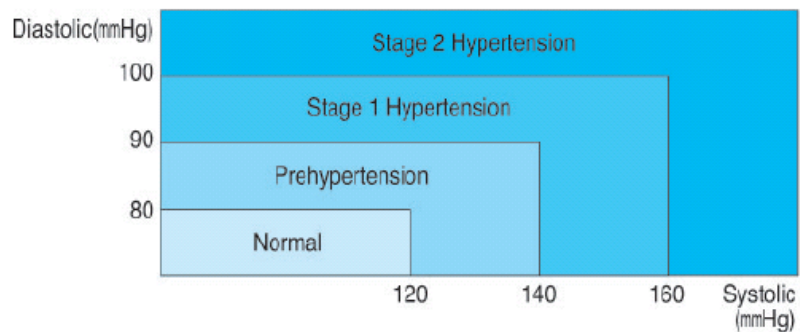

## Note



- When pressure is high with the jammed air hose, message appears on the printer as ERROR PRESSURE.

When the message is repeated, call for maintenance service.

- When pressure is low as air leaks, message appears on the printer as ERROR CUFF.

When the message is repeated, call for maintenance service.

- When the subject moves or speaks while in testing, message appears on the printer as ERROR MEASURE.

Try to retest after a while. If the message is repeated, call for maintenance service.

## OPTION

### 1. Reverse monitor

#### 1) Attachment of the reverse monitor

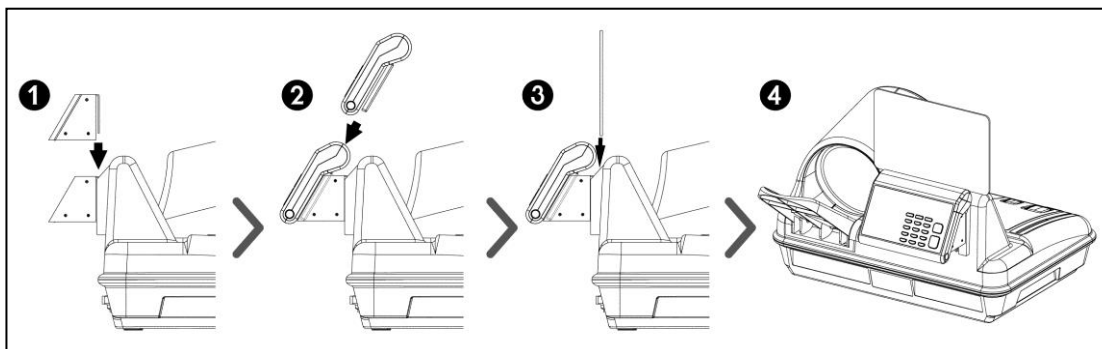

- ① Put support of reverse monitor in the direction of arrow.
- ② Attach reverse monitor into reverse monitor support as above.
- ③④ Put guide board in the direction of arrow and then complete it.

#### 2) Connect

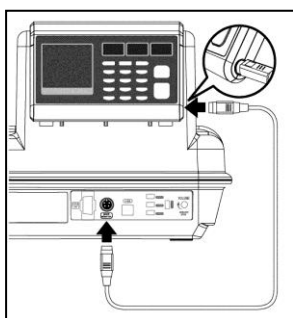

Connect reverse monitor and a blood pressure monitor to the rear 'BACK MONITOR PORT' in the body, using cable.

#### 3) Composition

- ① LCD display
  - Shows information and proceedings.
  - Also marks result, such as B.M.I. and fatness after completing the measurement.
- ② Indicating part of systolic blood pressure
  - Indicating the measured systolic blood pressure.
- ③ Indicating part of the diastolic blood pressure
  - Indicating the measured diastolic blood pressure.
- ④ Indicating part of pulse
  - Indicating the measured pulse.
- ⑤ ID button
  - Used when putting user's ID number.

⑥ Weight button

Used when putting user's body weight.

⑦ Height button

Used when putting user's height.

⑧ Numbers and • button

Used when putting numbers such as ID, body weight, height etc.

Use '•' button in order to put a decimal point in case of body weight, height.

For example, if body weight is 68.9kg, put 'weight button→6→8→•→9' in order.

⑨ Print button

Press in the result screen, and the measured result is printed.

⑩ STOP button

When you push a button while putting some information, the information is all removed, and initialized.

When pushing a button while measuring, stop measuring, and therefore cuff is back to the original state.

⑪ START button

When pushing a button after putting ID, weight and height, automatically cuff is pressurized and it starts measuring.

Reverse monitor

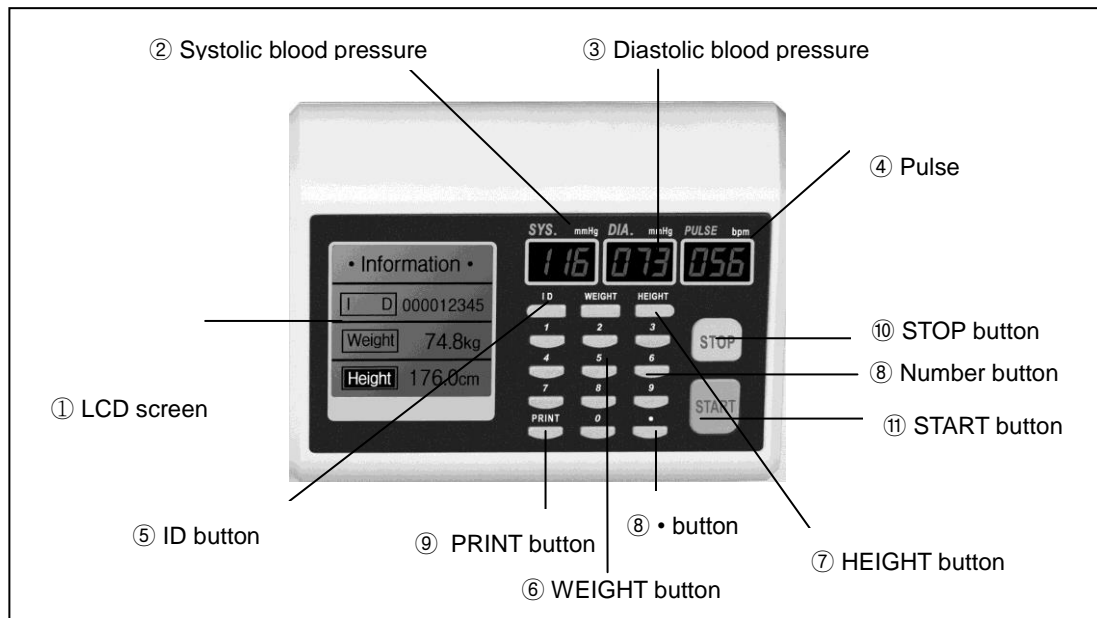



4) Measurement

① Input data

ID: After pressing 'ID' button in the initial screen, put ID, using 0~9 numeric button.  
 (go back to the initial screen unless you don't put for 40 seconds.)  
 - ID limitation you can put is 000000001~999999999.

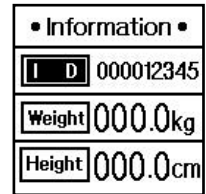

Weight: After putting ID, putting 'WEIGHT' button, you put body weight, using 0~9 numeric button. (go back to the initial screen unless you don't put for 40 seconds.)  
 - Body weight limitation you can put is 10.0~248.0kg.

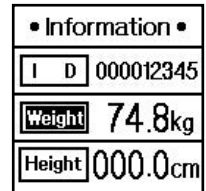

Height: After putting body weight, putting 'HEIGHT' button, you put height, using 0~9 numeric button. (go back to the initial screen unless you don't put for 40 seconds.)  
 - Height limitation you can put is 10.0~238.0cm.

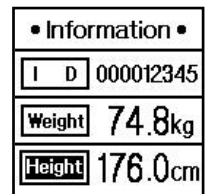

<b>Note</b>	<p>In case of cardholders, in putting card, private information(ID, weight, height) is displayed in reverse monitor.</p> <p>In case for you to want to modify weight or height, you push 'weight' button or 'height' button, and then modify it.</p> <p>When putting card, it's impossible for you to modify ID.</p>
	

② Measurement

When you finish input data, press 'START' button, and then begin to measure.  
 When measurement is begun, animation notifying 'measuring' is displayed.



<b>Note</b>	<p>When putting reverse monitor, you must push 'START' button on reverse monitor, and then height, weight, body mass index, fatness is displayed in the screen of thermal paper and reverse monitor.</p> <p>Since weight, height you put is reflected on the result body mass index(B.M.I.), fatness, you must put accurately.</p>
	

③ Result

When measurement is complete, body mass index (B.M.I.), fatness is displayed based on ID, weight and height in LCD.

●●● Result ●●●	
I D	000012345
B.M.I.	24.1kg/m <sup>2</sup>
Fatness	109%

④ Standard for judging result

- Body Mass Index (B.M.I.): this is calculated by dividing body weight by the square of height in meter.

section	thin	normal	overweight	obese
	<18.5kg/m <sup>2</sup>	18.5~<25.0kg/m <sup>2</sup>	25.0~<30.0kg/m <sup>2</sup>	30kg/m <sup>2</sup> and over

- Fatness: value showing your current fatness of weight for standard weight(%)

$$[\{(current\ weight - standard\ weight) / standard\ weight\} \times 100] + 100$$

$$standard\ weight = height(m)^2 \times 22$$

section	Very thin	thin	normal	overweight	obese
	<80%	80%~90%	90%~110%	110%~120%	>120%

## 2. MAGNETIC CARD

Machine manager can issue cards through supportive card issuer, in machine's delivery, you can issue it yourself.

When machine manager issues cards, please refer to card issuer or program manual.

### 1) Setting



In card's using, you should set CARD ON/OFF in the rear part by 'ON'.

#### Note



CARD ON/OFF switch of the rear part of the machine must be set by 「ON」 in order to use card. In using card, if the validation date has been expired, or the damaged card is inserted, the voice message "You cannot use ID card." appears. In this case, you purchase a new card, and insert, so you can measure.

### 2) Measurement

#### ① Card recognition

You hold your card and then swipe it up and down from card reader.

If card is recognized normally, it sounds 'Ttiriring~', and it becomes in the state of being ready for measurement.

In connected reverse monitor, ID stored in a card is displayed in the reverse monitor.

(Then, you can put weight and height in the reverse monitor.)

#### ② Measurement

If you finish recognizing card, voice and message 'Please press the start button' comes out. Push the start button, and then begin to measure. When measurement started, cuff pressure begins.

#### ③ Result

When the measurement is completed, systolic blood pressure, diastolic blood pressure, pulse is displayed on the LED.

④ Print-out the result of the measurement

▼ using only magnetic card

ID-NO.....000000005  
 DATE.....30/04/2008  
 TIME.....15:23  
 SYSTOLIC.....126 mmHg  
 DIASTOLIC.....070 mmHg  
 MEANPRESS.....088 mmHg  
 PULSEPRESS.....056 mmHg  
 PULSE.....082 bpm

The result is prehypertension.  
 Refer to the results and consult  
 to physician.

**PULSE WAVE PATTERN**

DATE/TIME	SYSTOLIC [mmHg]	DIASTOLIC [mmHg]	PULSE [bpm]
30.04.08 14:39	112	66	83
30.04.08 12:12	111	60	77
29.04.08 14:36	119	90	63
25.04.08 20:20	119	72	81
24.04.08 13:36	156	90	81
23.04.08 19:16	105	60	78

▼ Magnetic Card + reverse monitor

ID-NO.....000000005  
 DATE.....30/04/2008  
 TIME.....15:23  
 SYSTOLIC.....126 mmHg  
 DIASTOLIC.....070 mmHg  
 MEANPRESS.....088 mmHg  
 PULSEPRESS.....056 mmHg  
 PULSE.....082 bpm  
 HEIGHT.....158.0cm  
 WEIGHT.....056.0kg  
 FATNESS.....101 %  
 B.M.I. ....22.4 Kg/m<sup>2</sup>

The result is prehypertension.  
 Refer to the results and consult  
 to physician.

**PULSE WAVE PATTERN**

DATE/TIME	SYSTOLIC [mmHg]	DIASTOLIC [mmHg]	PULSE [bpm]
30.04.08 14:39	112	66	83
30.04.08 12:12	111	60	77
29.04.08 14:36	119	90	63
25.04.08 20:20	119	72	81
24.04.08 13:36	156	90	81
23.04.08 19:16	105	60	78

### 3. RFID card

Machine manager can issue cards through supportive card issuer, in machine's delivery, you can issue it yourself.

When machine manager issues cards, please refer to card issuer or program manual.

#### 1) Setting



In card's using, you should set CARD ON/OFF in the rear part by 'ON'.

#### 2) Measurement

##### ① card recognition

You hold your card and then touch on card reader.

If card is recognized normally, it sounds 'Ttiring~', and it becomes in the state of being ready for measurement.

In connected reverse monitor, ID stored in a card is displayed in the rear monitor.

(Then, you can put weight and height in the reverse monitor.)

##### ② Measurement

If you finish recognizing card, voice and message 'Please press the start button' comes out. Push the start button, and then begin to measure.

When measurement started, cuff pressure begins.

##### ③ Result

When the measurement is completed, systolic blood pressure, diastolic blood pressure, pulse is shown in the LED.

#### Note



1. In using card(Magnetic&RFID card), previous measured result is stored by six times, it shows the total seven times measured result including current measure result. When you push 'START' button in the result screen, the current measured result and six times accumulated data is displayed in LCD. In Printing-out, the current measured result and the accumulated data confirming change of blood pressure are output.
2. In case of using card and reverse monitor(option), you put your weight and height after putting card. Then both B.M.I. and fatness are output. Weight and height in reverse monitor are stored, and in case of remeasuring it, you don't need to repeat it.  
(The method of putting for the reverse monitor, please refer to p. 24.)

④ output the result of measurement

▼ in using only RFID card

ID-NO.....000000005  
 DATE.....30/04/2008  
 TIME.....15:23  
 SYSTOLIC.....126 mmHg  
 DIASTOLIC.....070 mmHg  
 MEANPRESS.....088 mmHg  
 PULSEPRESS.....056 mmHg  
 PULSE.....082 bpm

The result is prehypertension.  
 Refer to the results and consult  
 to physician.

**PULSE WAVE PATTERN**

DATE/TIME	SYSTOLIC [mmHg]	DIASTOLIC [mmHg]	PULSE [bpm]
30.04.08 14:39	112	66	83
30.04.08 12:12	111	60	77
29.04.08 14:36	119	90	63
25.04.08 20:20	119	72	81
24.04.08 13:36	156	90	81
23.04.08 19:16	105	60	78

▼ RFID card+ in putting the rear monitor

ID-NO.....000000005  
 DATE.....30/04/2008  
 TIME.....15:23  
 SYSTOLIC.....126 mmHg  
 DIASTOLIC.....070 mmHg  
 MEANPRESS.....088 mmHg  
 PULSEPRESS.....056 mmHg  
 PULSE.....082 bpm  
 HEIGHT.....158.0cm  
 WEIGHT.....056.0kg  
 FATNESS.....101 %  
 B. M. I. ....22.4 Kg/m<sup>2</sup>

The result is prehypertension.  
 Refer to the results and consult  
 to physician.

**PULSE WAVE PATTERN**

DATE/TIME	SYSTOLIC [mmHg]	DIASTOLIC [mmHg]	PULSE [bpm]
30.04.08 14:39	112	66	83
30.04.08 12:12	111	60	77
29.04.08 14:36	119	90	63
25.04.08 20:20	119	72	81
24.04.08 13:36	156	90	81
23.04.08 19:16	105	60	78

## MAINTENANCE

This unit is for 230V. If you want 110V, please contact to a service center.

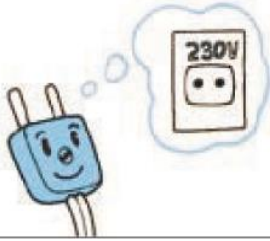

Remind the permitted current(60VA).



Do not disassemble the main body.



To prevent electric shock, please make sure the earth.

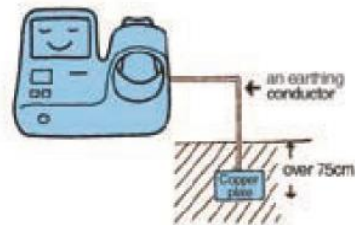

When grounded, do not mount it close to the gas pipe, water pipe, lightning rod and connection of telephone.



When you take out the plug, grasp the plug exactly.



Keep the unit dry and do not wet it. Never immerse the main unit in the water. It could cause damage the electronic parts inside.



Avoid direct sunshine, humidity, dust and extreme changes in temperature.

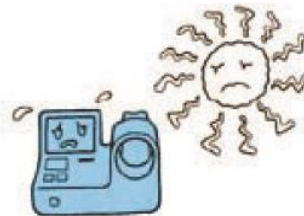

Do not put heavy things on the unit.



Wipe the unit with a damp cloth. Do not use benzene, alcohol or liquid similar to solvents and wet cloth.

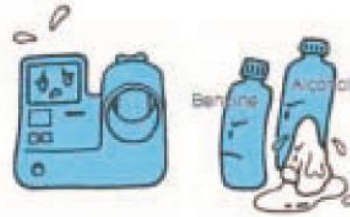

Check the unit conditions occasionally.



Do not use the unit under the condition of shock or vibration.



Do not install and shock with chemicals or gas.



When you re-use after a long time, please check the unit carefully.



When some problems are found, please call our service center.





## ERROR & REPAIR

Error	Cause	Repair
ERROR PRESSURE	pressure is high with the jammed air hose	When the message is repeated, call for maintenance service.
ERROR CUFF	pressure is low as air leaks	When the message is repeated, call for maintenance service.
ERROR MEASURE	subject moves or speaks while in testing	<ul style="list-style-type: none"><li>- Don't move or speak.</li><li>- When the message is repeated, call for maintenance service.</li></ul>

## AFTER SERVICE

### 1. AFTER SERVICE

- ! If there is any problem with the unit, please follow the steps below;
  - ※ Contact our company's Overseas Service Department immediately.  
After gathering the model name, Serial Number, date of purchase and description of the problem, contact our company with information shown below.
  - ※ Try to solve the problem over the phone with the personnel of local service department.  
If the problem cannot be solved over the phone, just return to service department directly.
  - ※ Our company or local distributor will make available on-request circuit diagrams, component part list, descriptions, calibration or other information which will assist your appropriately qualified technical personnel to repair those parts of unit which are designated by our company as repairable.

How to contact our company

Write us at:

SELVAS Healthcare, Inc.

155, shinseong-ro, Yuseong-gu, Daejeon, 34109 Republic of Korea

TEL: 82-42-879-3000

FAX: 82-42-864-4462

(You can also contact the following representative or your local distributor)

### 2. PACKING AND TRANSPORT

Our company follows his packing ways to protect any impact during transporting etc. So please do not transport or move the unit without our company's packing condition as your wishes.

The normal storage environment; -20°C~ 60°C of temperature, Humidity is less than 95% non-condensing.

## SPECIFICATION

Model	ACCUNIQ BP210 (Right type)	ACCUNIQ BP210 (Left type)
Measuring method	Oscillometric	
Display mode	High Brightness LED (197X145mm) display	
Result Contents	Systolic/Diastolic/Mean blood pressure, Pulse pressure, Pulse, Blood pressure assessment, Pulse wave pattern Reverse Monitor(Optional): Systolic/Diastolic blood pressure, Pulse, ID No, B.M.I., and Fatness	
Measuring range	Pressure 30~300mmHg, Pulse 30~200beats/minute	
Accuracy	Pressure $\pm 3$ mmHg or $\pm 3\%$ , Pulse $\pm 3\%$	
Resolving Power	1mmHg	
Pressurizing method	DC Motor	
Cuff type	Belt type	
Pressurizing time	Approx. 10 seconds	
Measuring time	Approx. 33 seconds	
Printer	Thermal printer	
Power supply	Input-AC 100~240V~, 50-60Hz, 1.5A Output-DC 12V, 5A, 60VA ADAPTER	
Power consumption	60VA	
Ambience for operation	Temperature 10~40°C, Humidity 30~75%	
Ambience for storage	Temperature -20~60°C, Humidity Less than 95%	
Data transmission	RS-232C	
Dimension	463(W) × 324(D) × 275.9(H) mm	
Weight	Approx. 11kg	
Measuring parts	ACCUNIQ BP210 (Right type): Right arm	ACCUNIQ BP210 (Left type): Left arm

## WARRANTY

### WARRANTY

Item	Automatic Blood Pressure Monitor	Warranty period
Model	ACCUNIQ BP210	2years (main unit only)
Serial NO.		

Date of purchase	Month	Day	Year
Customer	Name:		TEL:
	Address:		
Dealer	Name:		TEL:
	Address:		

Date	Defection	Confirmation

#### Note



- When you receive this warranty, make sure that the name of the dealer and the month, day and year of purchase are all completed.
- This warranty will not be reissued, please keep it in a safe place.

## Periodic Check List

Management No. \_\_\_\_\_

Item		Inspection Subject	Requirements	Judgment	Remarks
<b>Visual Check</b>					
Mainframe	1	Enclosure	No scratch, crack, deformation and rust	Pass/Fail	
	2	Labels and panels	No peeling and dust	Pass/Fail	
	3	Keys	No damage	Pass/Fail	
	4	Cuffs	No scratch and damage	Pass/Fail	
Accessories	1	Power cord	No scratch and damage	Pass/Fail	
	2	User manual	Kept in proper place	Pass/Fail	
<b>Mechanical Check</b>					
Mainframe	1	Keys	Smooth operation	Pass/Fail	
	2	Recorder	Smooth operation with no abnormal sound	Pass/Fail	
	3	Cuffs	Smooth operation	Pass/Fail	
Accessories	1	Power cord	Smooth operation and removal	Pass/Fail	
<b>Electrical Check</b>					
Performance	1	Power supply	Screen display upon power-on	Pass/Fail	
	2	Display	No abnormality and flickering	Pass/Fail	
	3	Printing	printing possible	Pass/Fail	
	4	Measurement	Proper measurement	Pass/Fail	
General Judgment				Pass/Fail	
Model		ACCUNIQ BP210		Serial No.	
Installation place			Date of purchase		
Check date		Checked by	Approved by		

Copy this sheet for use

If repair is required, write down so in the Remarks column.

## Daily Check List

Management No. \_\_\_\_\_

Item		Inspection Subject	Requirements	Judgment	Remarks
<b>Visual Check</b>					
Mainframe	1	Enclosure	No scratch, crack, deformation and rust	Pass/Fail	
	2	Labels and panels	No peeling and dust	Pass/Fail	
	3	Keys	No damage	Pass/Fail	
	4	Cuffs	No scratch and damage	Pass/Fail	
Accessories	1	Power cord	No scratch and damage	Pass/Fail	
	2	User manual	Kept in proper place	Pass/Fail	
<b>Mechanical Check</b>					
Mainframe	1	Keys	Smooth operation	Pass/Fail	
	2	Recorder	Smooth operation with no abnormal sound	Pass/Fail	
Accessories	1	Power cord	Smooth operation and removal	Pass/Fail	
<b>Electrical Check</b>					
Performance	1	Power supply	Screen display upon power-on	Pass/Fail	
	2	Display	No abnormality and flickering	Pass/Fail	
	3	Printing	Waveform printing possible	Pass/Fail	
	4	Measurement	Proper measurement	Pass/Fail	
Other	1	Clock	Present date/time	Pass/Fail	
General Judgment				Pass/Fail	
Model		ACCUNIQ BP210		Serial No.	
Installation place			Date of purchase		
Check date		Checked by	Approved by		

Copy this sheet for use

If repair is required, write down so in the Remarks column.



**SELVAS Healthcare, Inc.**

**HEADQUARTERS:**

155, Shinseong-ro, Yuseong-gu, Daejeon, 34109 Republic of Korea

TEL:82-42-879-3000 FAX:82-42-864-4462

**SEOUL OFFICE (Sales):**

20F Daerung Techno Town 18th, 19, Gasan digital 1-ro, Geumcheon-gu, Seoul, 08594, Republic of Korea

TEL:82-2-587-4056 FAX:82-2-588-1937

**EUROPEAN REPRESENTATIVE**

VITAKO Sp. z o.o.

ul. Stanisława Żaryna 7c 02-593 Warszawa, POLAND

TEL: +48 505 522 888

If the problems continue, call the service center. When you ask for service, the manufacturer's label, serial number, date of original purchase and explanation of malfunction will be required.

**Service center**

**TEL : 02-587-4056  
042-879-3000**

※ For purposes of improvement, specifications and design are subject to change without notice.



BP210E-20170918 Rev 2.0